

Post Caps

External

	Size	Box Qty.	Item#	Less Box	Box
White	4" x 4"	125	IVC0100		
	5" x 5"	160	IVC0110		
Tan	4" x 4"	125	IVC0101		
	5" x 5"	160	IVC0111		
Stone	4" x 4"	125	IVC0102		
	5" x 5"	160	IVC0112		



Gothic

	Size	Box Qty.	Item#	Less Box	Box
White	4" x 4"	45	IVC0200		
	5" x 5"	45	IVC0210		
Tan	4" x 4"	45	IVC0201		
	5" x 5"	45	IVC0211		
Stone	4" x 4"	45	IVC0202		
	5" x 5"	45	IVC0212		



Ball Top

	Size	Box Qty.	Item#	Less Box	Box
White	4" x 4"	60	IVC0300		
	5" x 5"	32	IVC0310		
Tan	4" x 4"	60	IVC0301		
	5" x 5"	32	IVC0311		
Stone	4" x 4"	60	IVC0302		
	5" x 5"	32	IVC0312		



Picket Caps

Sharp

	Size	Box Qty.	Item#	Less Box	Box
White	0.875" x 1.5"	400	IVC1420		
Tan	0.875" x 1.5"	400	IVC1421		



Sharp, Self-Locking

	Size	Box Qty.	Item#	Less Box	Box
White	0.875" x 3"	250	IVC1430		
Tan	0.875" x 3"	250	IVC1431		



Dog Ear, Self-Locking

	Size	Box Qty.	Item#	Less Box	Box
White	0.875" x 3"	300	IVC1530		
Tan	0.875" x 3"	300	IVC1531		

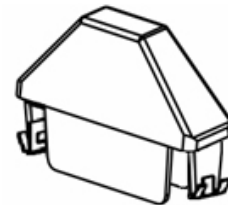

Rail Caps

Flat End Caps

	Size	Box Qty.	Item#	Less Box	Box
White	1.5" x 5.5"	400	IVC2640		
Tan	1.5" x 5.5"	400	IVC2641		
Stone	1.5" x 5.5"	400	IVC2642		

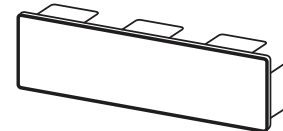

Brackets For Ranch Rail

Post Mount Brackets (Face Mount)

	Size	Box Qty.	Item#	Price
White	1 1/2" x 5 1/2"	108	IVMA6	
White	2" x 6"	63	IVMB6	
Tan	2" x 6"	63	IVMB7	

Inside Rail Mount Brackets

White	1 1/2" x 5 1/2"	100	IVMC6	
Tan	1 1/2" x 5 1/2"	100	IVMC7	

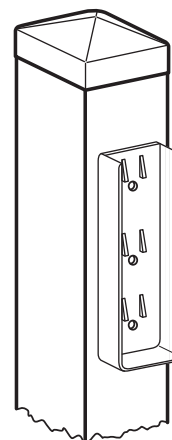

IVMC6

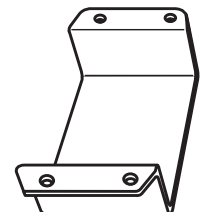

IVMA6 / IVMB6

Notching Tool

Description	Item#	Price
Notching tool for vinyl fence	IVMD	

Stiffeners

Post Stiffener, 14-Gauge (Steel)

Size	Box Qty.	Item#	Less Box	Box
4" x 4" x 72"	40	IVS210		
5" x 5" x 96"	40	IVS311		

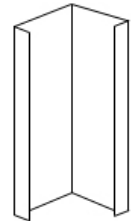

IVS210 / IVS311

Post Stiffener Aluminum

5" x 5" x 84"	12	IVS322	82.12	73.91
---------------	----	--------	-------	-------

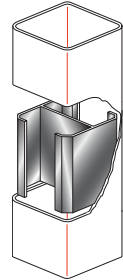

IVS322

1.5" x 5.5" Rail Stiffener, 24-Gauge (Steel)

Size	Box Qty.	Item#	Less Box	Box
96"	100	IVS101		



IVS101

Glue

PVC Glue

	Size	Box Qty.	Item#	Less Box	Box
White	8 oz Tube	24	IVM24W		
Tan	8 oz Tube	24	IVM24T		
White	1.5 oz Tube	24	IVM23W		
Tan	1.5 oz Tube	24	IVM23T		

Hole Plugs

	Size	Box Qty.	Item#	Less Box	Box
White	0.625"	500	IVM36		
Tan	0.625"	500	IVM37		



Snap Caps And Washers

Snap Cap

	Box Qty.	Item#	Less Box	Box
White	1,000	IVM46		
Tan	1,000	IVM47		



Snap Cap Washer

1,000	IVM5		
-------	------	--	--

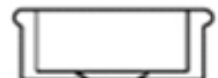

Hinges

Vinyl to Vinyl, Non Self-Closing

	Box Qty.	Item#	Less Box	Box
White	12	IVH00		
Black	12	IVH01		

Vinyl to Vinyl, Self-Closing

White	12	IVH10		
Black	12	IVH11		

Vinyl to Steel, Non Self-Closing

White	12	IVH40		
Black	12	IVH41		

Vinyl to Steel, Self-Closing

White	12	IVH50		
Black	12	IVH51		

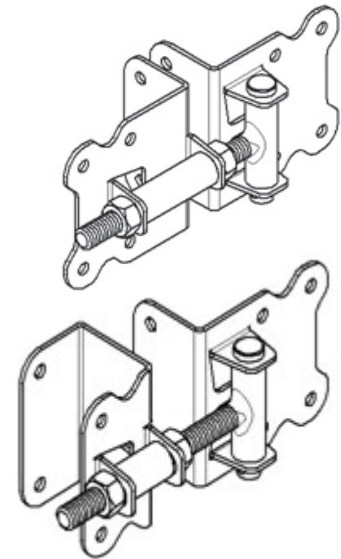

Paddle Latches

	Box Qty.	Item#	Less Box	Box
White	20	IVH30		
Black	20	IVH31		

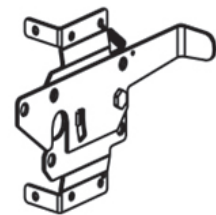

Drop Rods

	Size	Box Qty.	Item#	Less Box	Box
White	36"	10	IVH20		
Black	36"	10	IVH21		

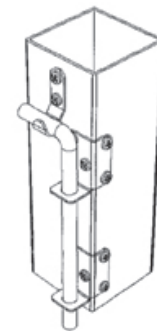

Aluminum Tubing

Size	Box Qty.	Item#	Less Box	Box
1.25" x 1.25" x 4'	100	IVM002		
1.25" x 1.25" x 6'	100	IVM008		
1.25" x 1.25" x 24'	100	IVM00A		
1.5" x 1.5" x 65.5"	100	IVM015		
1.5" x 1.5" x 22'	100	IVM019		

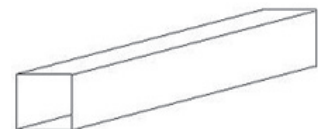

Aluminum Gate Corners

Degree	Box Qty.	Item#	Price
90	50	IVM12	

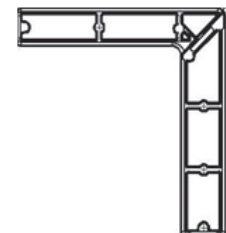

RANCH 3 Rail Fence Gate Frame

Item#	Opening	Unit Price
45036W	Up to 6 ft	

PVC Rigid Profiles Not Supplied with Gate

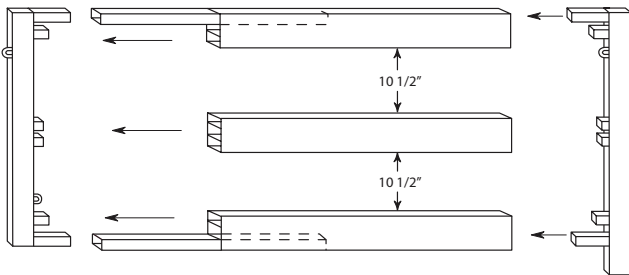

ADJUST-A-GATE

- Square frame design for professional quality
- Kit includes: vertical frame, 6' spreader bars, post hinges, frame hinges, gate latch, truss cable, stainless steel screws
- 180° hinge system
- Easy "on-site" assembly

CONSTRUCTION

- Fade and rust resistant, white powder coat over galvanized steel
- 2" x 2" square frame
- 6' galvanized spreader bars
- Each kit will cover an opening of up to 6'
- Available in white (call for special order colors)

Adjustable Steel Frame For Wood Fencing

Item#	Description	Price
26300-36	AG 36 36" - 60" opening	
26300-36-3	Contractor Series 3-Rail — AG 36-3	
26300-60	AG 60 60" - 96" opening	
26300-60-3	Contractor Series 3-Rail — AG 60-3	
26310-301	UL-301 Galvanized Drop Rod Assembly For Wood Gate	

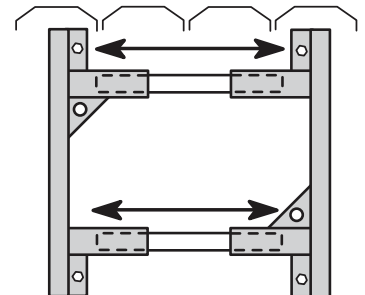

- **Galvanized Hardware Included**
Gate Frame Hinges, Lag Hinges, Zinc Thumb Latch, Stop Plate, Cable Truss Kit
- **Galvanized Steel Frame**
With tan polyester powder coated
- **Wood Not Supplied With Frame**

Item#	Gate Latches	Price
15991	UL-101 notched for round post weld-on, ZINC	
15995	UL-103 flat bolt-on, ZINC	
15997	UL-104 notched for round post bolt-on, ZINC	
45403	UL-302 double drive drop rod white powder coated for vinyl gate. Includes: 1 — UL-302 drop rod 2 — UL-302 drop rod guides	

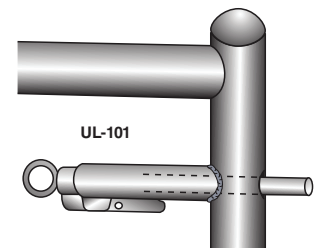

- Genuine red cedar beauty and durability.

WARNING

Drilling, sawing, sanding or machining wood products generates wood dust, a substance known to the State of California to cause cancer. Avoid inhaling wood dust or use a dust mask or other safeguards for personal protection.

California Health and Safety Code Section 25249.6

RED CEDAR SPLIT RAIL FENCING

Description	Item#	Weight Each		Pieces Per Unit	Price
		(lbs.)	Girth		

2-RAIL — 5'4" Approximate length Standard Weight

Line Post	55009	23	18"	72
End Post	55011	23	18"	72
Corner Post	55010	25	18"	68

3-RAIL — 6'6" Approximate length Standard Weight

Line Post	55012	29	18"	72
End Post	55013	29	18"	72
Corner Post	55014	32	18"	68

RAILS — 8', 10' Standard Weight

10'	55015	20	12 - 14"	155
8'	55016	16	12 - 14"	160

GATES

2 Rail x 42" Gate	55020	59		1
2 Rail x 60" Gate	55021	97		1
3 Rail x 42" Gate	55022	78		1
3 Rail x 60" Gate	55023	111		1

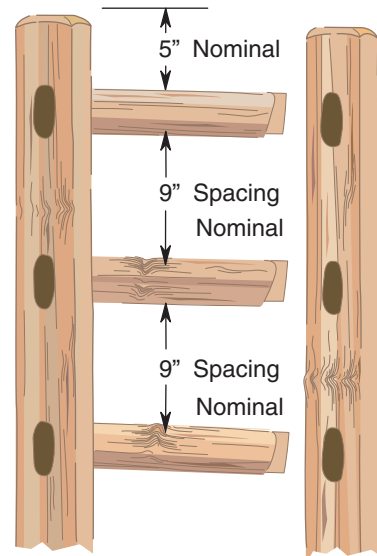
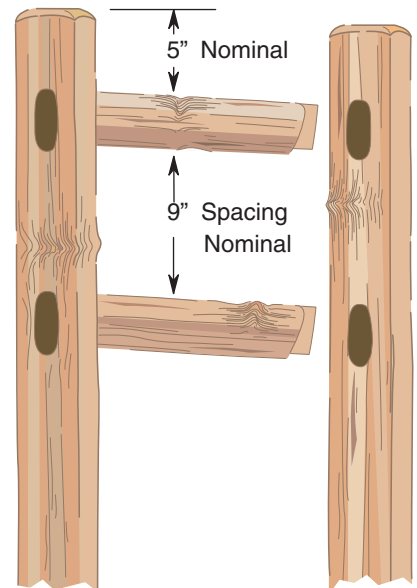

Purchase by the bundle quantity & save 10%

TEMPORARY FENCE PANEL

Item#	Description	Price	
		Less Bundle	20 per Bundle
TP610	10 ft Fence Panel		
TP612	12 ft Fence Panel		

Each

TPSS Square Stand
TPTS "T" Stand

Specifications

- 6 ft in height
- 10' and 12' widths
- 1 3/8" tube frame
- 11 1/2 gauge fill

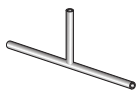

8" H x 30" L

TPTS

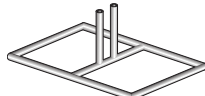

30" L x 18" W
with 8" high uprights

TPSS

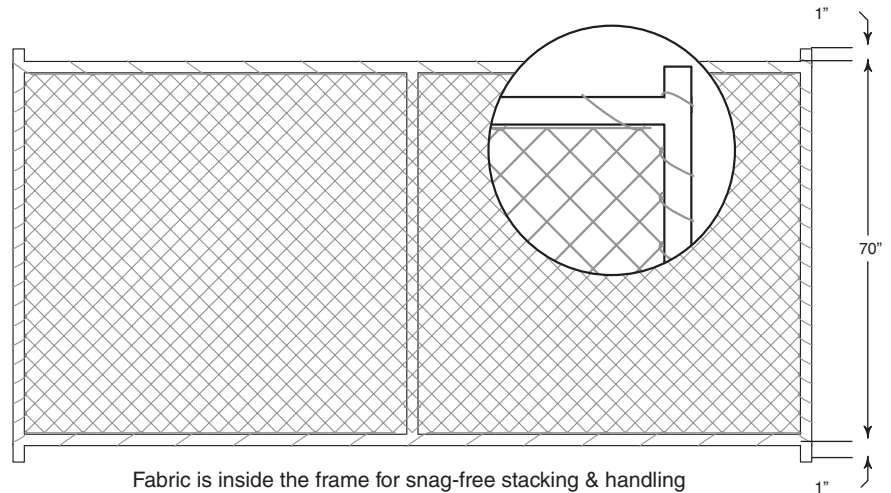

Fabric is inside the frame for snag-free stacking & handling

CROWD CONTROL PANEL

Hot Dipped Galvanized

Item#	Description	Price	
		Less Bundle	20 per Bundle

TPCC Crowd Control Fence
42" height x 90" length
2 stands included with each panel

Specifications

- Weight 55 lbs.
- 18 pickets total
- 3.75" picket spacing
- 3/4" round pickets
- 1 5/8" pipe frame

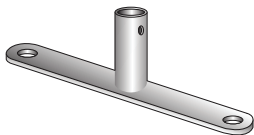

8" H x 21" L x 2 5/16" W
2) 1" holes, 1 7/8" pipe

Stand

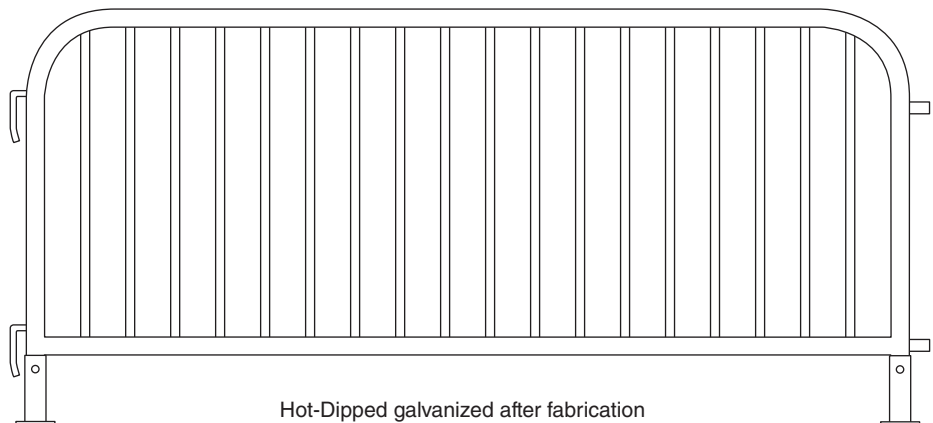

Hot-Dipped galvanized after fabrication



Galvanized metal fence post for wood fences.



Item #	Description	Qty.	Weight Each	Price Each	
				Less Bundle	Bundle (100)
ZEEP084	7'	100	18 lbs.	27.47	22.89
ZEEP090	7' 6"	100	20 lbs.	28.78	23.98
ZEEP096	8'	100	21 lbs.	30.88	25.73
ZEEP108	9'	100	23 lbs.	37.80	31.50
ZEEP120	10'	100	26 lbs.	39.86	33.22

- 11 GA Galvanized to G90
- No brackets needed
- Withstand wind gusts of up to 72 miles an hour
- Can also easily be concealed by placing a 6" board over the post

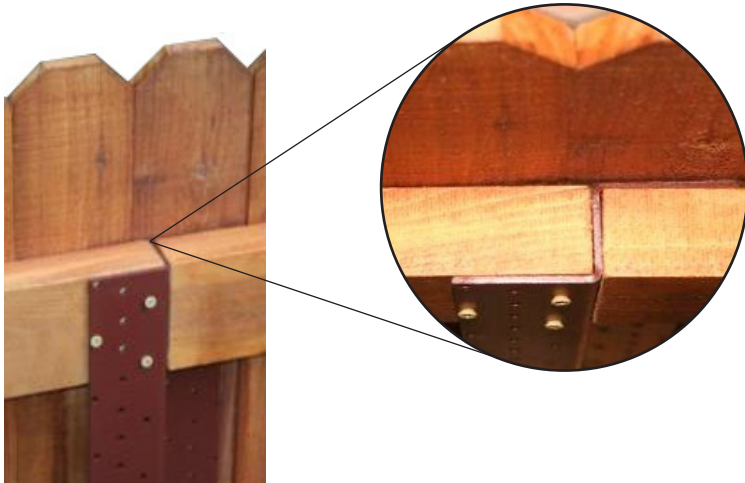

Hole patterns make installation easy
 Can be used as a line post, corner post, gate post
 or end post with no hardware or brackets

The Z/Post works as a natural gate stop.

