

TABLE OF CONTENTS

Styles and Grades listed by Finish Options

GALVA-GUARD I

<i>LIGHT REGAL,</i>	<i>Galva-Guard I</i>	<i>Pages 2-3</i>
<i>HEAVY REGAL,</i>	<i>Galva-Guard I</i>	<i>Pages 4-7</i>
<i>LIGHT ARISTOCRAT,</i>	<i>Galva-Guard I</i>	<i>Pages 8-9</i>
<i>HEAVY ARISTOCRAT,</i>	<i>Galva-Guard I</i>	<i>Pages 10-13</i>
<i>HEAVY GUARDIAN,</i>	<i>Galva-Guard I</i>	<i>Pages 14-17</i>

POWDER COATED

<i>LIGHT REGAL, Biasable</i>	<i>Powder Coat</i>	<i>Page 17A</i>
<i>LIGHT ARISTOCRAT, Posts</i>	<i>Powder Coat</i>	<i>Page 17B</i>

TWO COAT ENAMEL

<i>LIGHT REGAL,</i>	<i>Two Coat</i>	<i>Pages 18-19</i>
<i>HEAVY REGAL,</i>	<i>Two Coat</i>	<i>Pages 20-23</i>
<i>LIGHT ARISTOCRAT,</i>	<i>Two Coat</i>	<i>Pages 24-25</i>
<i>HEAVY ARISTOCRAT,</i>	<i>Two Coat</i>	<i>Pages 26-29</i>
<i>HEAVY GUARDIAN,</i>	<i>Two Coat</i>	<i>Pages 30-33</i>
<i>LIGHT EMPIRE,</i>	<i>Two Coat</i>	<i>Pages 34-35</i>
<i>LIGHT MODERN,</i>	<i>Two Coat</i>	<i>Pages 36-37</i>
<i>LIGHT NAPOLEON,</i>	<i>Two Coat</i>	<i>Pages 38-39</i>

ONE COAT ENAMEL

<i>LIGHT REGAL,</i>	<i>One Coat</i>	<i>Pages 40-41</i>
<i>LIGHT ARISTOCRAT,</i>	<i>One Coat</i>	<i>Pages 42-43</i>
<i>LIGHT EMPIRE,</i>	<i>One Coat</i>	<i>Pages 44-45</i>
<i>LIGHT MODERN,</i>	<i>One Coat</i>	<i>Pages 46-47</i>
<i>LIGHT REGAL Biasable,</i>	<i>One Coat</i>	<i>Page 48</i>

TRASH ENCLOSURE *Page 49*

CANTILEVER GATES *Page 50*

PICKET POSITION

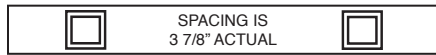

- 1" Square Top & Bottom Rail, 16 ga.
- 5/8" Square Pickets, 18 ga.
- 4" (3 7/8" actual) Spacing between Pickets
- Tubing Galvanized before Fabrication
- Power Washed for Paint Preparation
- One Spray Coat High Solids Primer
- One Spray Coat Polyurethane Black
- Custom Colors Available at Additional Cost
- Choose from 14 Standard Colors — add 5%

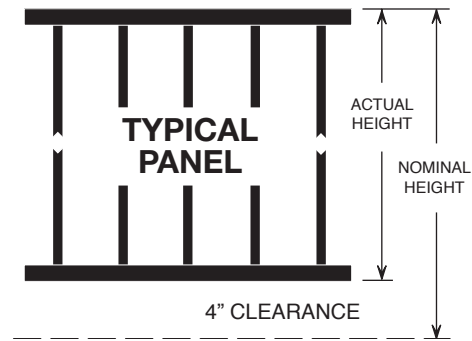

LIGHT REGAL, Galva-Guard I, Conventional sizes

PRE-GALVANIZED TUBING & POLYURETHANE PAINTED

Panels

	Nominal Height Actual Height	3' 32"	3 1/2' 38"	4' 44"	5' 56"	SPECIAL 58"	6' 68"
94" length	Item Number	68010-GI	68040-GI	68110-GI	68210-GI	68211-GI	68310-GI
	Weight in Pounds	33	37	41	49	53	57
120" length	Item Number	68020-GI	68050-GI	68120-GI	68220-GI	68221-GI	68320-GI
	Weight in Pounds	42	47	52	62	64	72
143 1/2" length	Item Number	68030-GI	68060-GI	68130-GI	68230-GI	68231-GI	68330-GI
	Weight in Pounds	50	56	62	74	76	86

Single Gates

Includes zinc plated standard hardware: an "A-Kit" and an "M-Kit"

	Nominal Height Actual Height	3' 32"	3 1/2' 38"	4' 44"	5' 56"	SPECIAL 58"	6' 68"
3' opening	Item Number	68409-GI	68414-GI	68419-GI	68429-GI	68421-GI	68439-GI
	Weight in Pounds	16	18	20	24	25	29
4' opening	Item Number	68410-GI	68415-GI	68420-GI	68430-GI	68431-GI	68440-GI
	Weight in Pounds	19	22	24	29	30	34

Double Gates

Includes zinc plated standard hardware: 2 "A-Kits" and an "R5-Kit"

	Nominal Height Actual Height	3' 32"	3 1/2' 38"	4' 44"	5' 56"	SPECIAL 58"	6' 68"
10' opening	Item Number	68449-GI	68454-GI	68459-GI	68469-GI	68461-GI	68479-GI
	Weight in Pounds	49	55	62	75	76	88
12' opening	Item Number	68450-GI	68455-GI	68460-GI	68470-GI	68471-GI	68480-GI
	Weight in Pounds	56	63	70	84	85	98

BFC Ornamental Iron

LIGHT REGAL
Galva-Guard I

LIGHT REGAL, Galva-Guard I, Non-Conventional Sizes

PANELS • Item # 68000-GI

To determine prices for non-standard sizes, use this list of "per foot" prices.

		HEIGHT							
		2'	3'	3 1/2'	4'	5'	6'	7'	8'
per foot	-XX								

SINGLE GATES • Item # 68400-GI

Single Gates include zinc plated standard hardware: an "A-kit" and an "M-kit".

		HEIGHT							
		2'	3'	3 1/2'	4'	5'	6'	7'	8'
WIDTH	3'								
	4'								
	5'								
	6'								
	7'								
	8'								
	9'								
	10'								

DOUBLE GATES • Item # 68455-GI

Double Gates include zinc plated standard hardware: 2 "A-kits" and an "R5-kit".

		HEIGHT							
		2'	3'	3 1/2'	4'	5'	6'	7'	8'
WIDTH	6'								
	8'								
	10'								
	12'								
	14'								
	16'								
	18'								
	20'								

Prices are for rectangular fence and gates only.

For BIAS fence and gates, add \$ per lineal foot.

For TAPERED fence and gates, add \$ per lineal foot.

FOR CUSTOM OPTIONS: arching, scroll work or a wide variety of design alternatives, see the **SPECIAL PRICING APPLICATIONS** section of this catalog.

PICKET POSITION

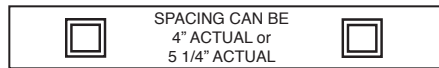

- 1 1/2" Square Top & Bottom Rail, 14 ga.
- 3/4" Square Pickets, 16 ga.
- 4" or 5 1/4" Spacing between Pickets
- Tubing Galvanized before Fabrication
- Power Washed for Paint Preparation
- One Spray Coat High Solids Primer
- One Spray Coat Polyurethane Black
- Custom Colors Available at Additional Cost
- Choose from 14 Standard Colors — add 5%

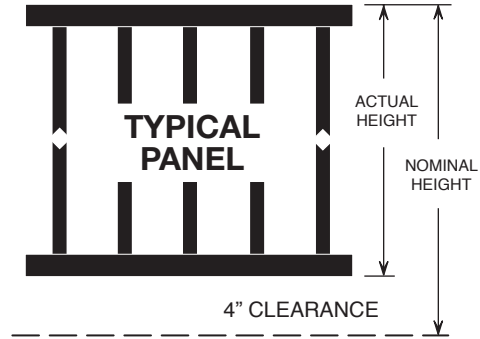

HEAVY REGAL, Galva-Guard I, Conventional sizes PRE-GALVANIZED TUBING & POLYURETHANE PAINTED

Panels, Conventional Sizes, 4" PICKET SPACING

	Nominal Height	5'	6'	7'	8'
94" length	Item Number	79010-GI	79020-GI	79030-GI	79040-GI
	Weight in Pounds	74.4	86.4	97.6	109.6
	Price				
118" length	Item Number	79012-GI	79022-GI	79032-GI	79042-GI
	Weight in Pounds	93	108	122	137
	Price				
141 3/4" length	Item Number	79014-GI	79024-GI	79034-GI	79044-GI
	Weight in Pounds	111.6	129.6	146.4	164.4
	Price				

Panels, Conventional Sizes, 5 1/4" PICKET SPACING

	Nominal Height	5'	6'	7'	8'
94" length	Item Number	79110-GI	79120-GI	79130-GI	79140-GI
	Weight in Pounds	61.6	70.4	78.4	88
	Price				
118" length	Item Number	79112-GI	79122-GI	79132-GI	79142-GI
	Weight in Pounds	77	88	98	111
	Price				
141 3/4" length	Item Number	79114-GI	79124-GI	79134-GI	79144-GI
	Weight in Pounds	92.4	105.6	117.6	132
	Price				

Panels, Non-Conventional Sizes, per foot

	Nominal Height	5'	6'	7'	8'
4" picket spacing	Item Number	79210-GI	79220-GI	79230-GI	79240-GI
	Weight in Pounds	9	11	12	14
	Price				
5 1/4" picket spacing	Item Number	79212-GI	79222-GI	79232-GI	79242-GI
	Weight in Pounds	7.7	8.8	9.9	11
	Price				

HEAVY REGAL, Galva-Guard I, Single Gate

Item # 79400-GI

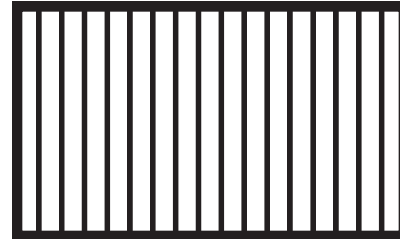
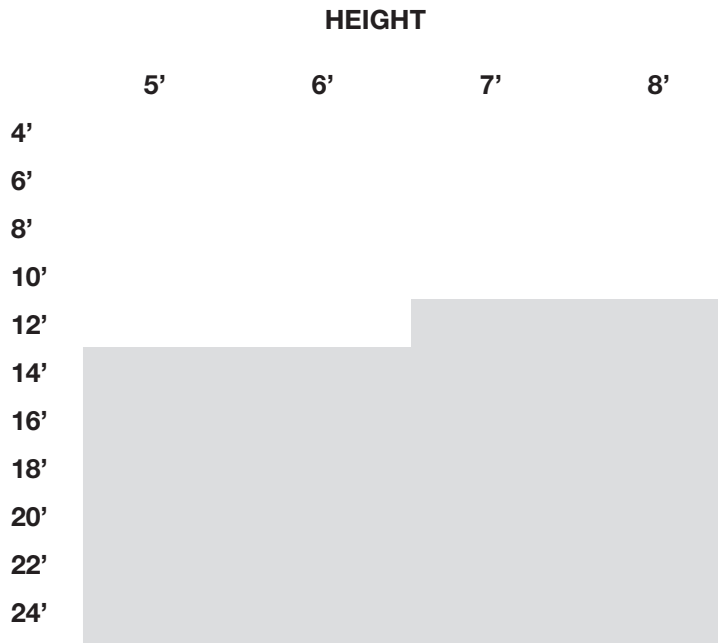

HEAVY REGAL, Galva-Guard I, Double Gate

Item # 79450-GI

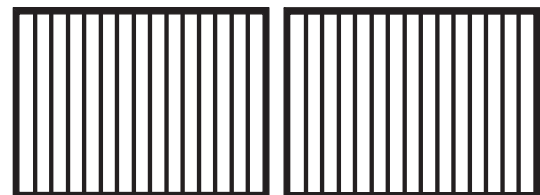
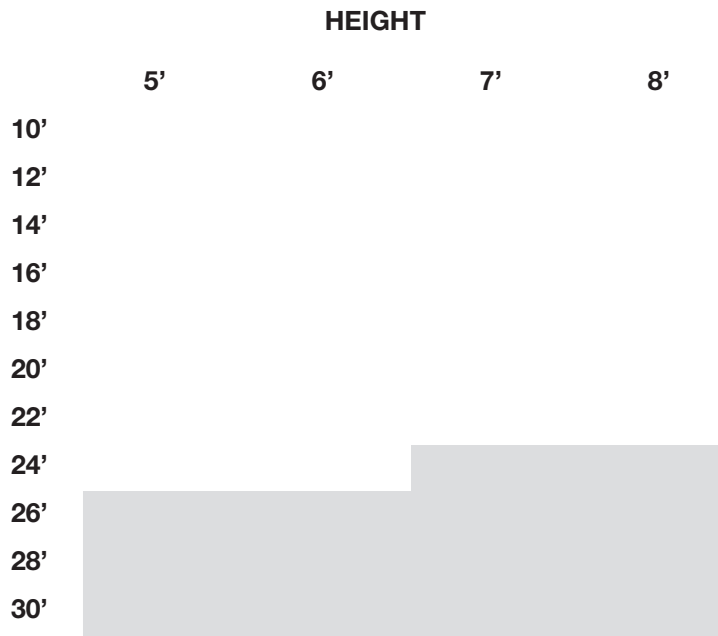

NOTES

Prices listed on this page are based on 4-inch picket spacing only and do not include hardware or trussing. Shaded areas on the pricing schedule indicate gates manufactured with a 2" frame required for additional strength.

FOR CUSTOM OPTIONS: arching, scroll work or a wide variety of design alternatives, see the **SPECIAL PRICING APPLICATIONS** section of this catalog.

Please call for special pricing.

CONVENTIONAL SLIDE GATE

GATE PRICES INCLUDE:

- 1 5/8" BFC 20 track
- 2 - P.S. pipe track wheels
- 2 - Clamp-on brackets
- 2 - P.S. caps
- 1 - 6" Rubber wheel
- Required track brackets
- Slide gate latch

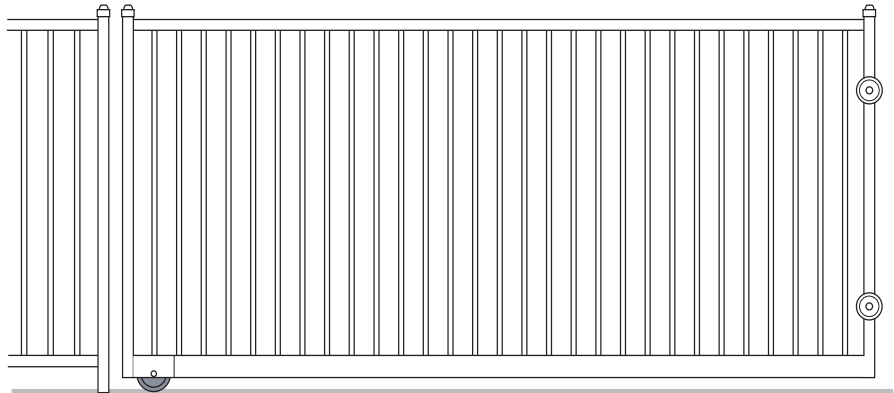

Item # 79474-GI

2" x 4" BOTTOM RAIL

Gates are manufactured with 2" top rail and sides with a 2" x 4" bottom rail (4" view), 3/4" sq. pickets and 4" picket spacing. Old style gates with square bottom rail and old style wheel boxes are available upon request.

Note: Ground clearance reduced to 2". Call for pricing on custom variations.

Note: UL 325 requires electronically operated gates and the fence line adjoining such gates to have a maximum 2 1/8" picket spacing or mesh installed. For additional cost, contact sales person.

HEAVY REGAL, Galva-Guard I, Conventional Slide Gate

HEIGHT

	3'	4'	5'	6'
O	8'			
P	10'			
E	12'			
N	14'			
I	16'			
N	18'			
G	20'			

FOR CUSTOM OPTIONS: arching, scroll work or a wide variety of design alternatives, see the **SPECIAL PRICING APPLICATIONS** section of this catalog.

Please call for special pricing.

GATE PRICES INCLUDE:

- 2 - P.S. caps
- 1 - Roller assembly
- 1 - Industrial slide latch
- 2 - 6" V-Groove wheels
- Galvanized V-Track with J-Bolts or Tabs

OVERHEAD ROLLER STYLE

End View
Detail

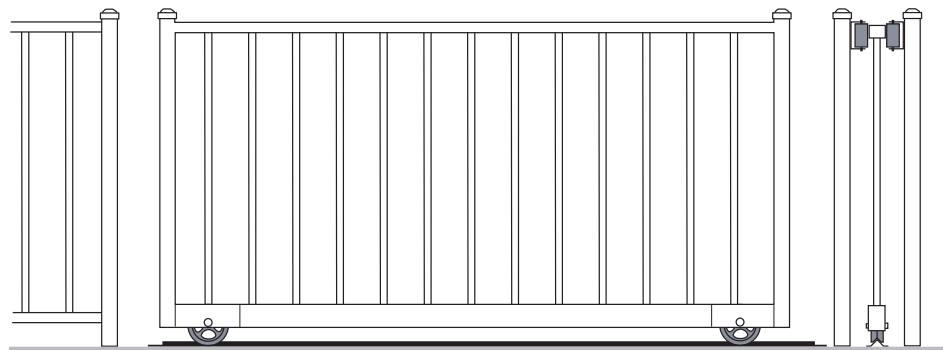

Item # 79475-GI

2" x 4" BOTTOM RAIL

Gates are manufactured with 2" top rail and sides with a 2" x 4" bottom rail (4" view), 3/4" sq. pickets and 4" picket spacing. Old style gates with square bottom rail and old style wheel boxes are available upon request.
Note: Ground clearance reduced to 2". Call for pricing on custom variations.

Note: UL 325 requires electronically operated gates and the fence line adjoining such gates to have a maximum 2 1/8" picket spacing or mesh installed. For additional cost, contact sales person.

HEAVY REGAL, Galva-Guard I, Overhead Roller Assembly Style Slide Gate

		HEIGHT					
		3'	4'	5'	6'	7'	8'
O P E N I N G	10'						
	12'						
	14'						
	16'						
	18'						
	20'						
	22'						
	24'						
	26'						
	28'						
30'							

Shaded areas on the pricing schedule indicate gates manufactured with an 11 gauge frame required for additional strength. Trussing is optional and may be required for larger gate sizes. Refer to **SPECIAL PRICING APPLICATIONS** section.

FOR CUSTOM OPTIONS: arching, scroll work or a wide variety of design alternatives, see the **SPECIAL PRICING APPLICATIONS** section of this catalog.

Please call for special pricing.

BFC Ornamental Iron LIGHT ARISTOCRAT Galva-Guard I

PICKET POSITION

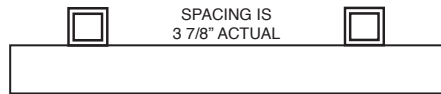

- 1" Square Top & Bottom Rail, 16 ga.
- 5/8" Square Pickets, 18 ga.
- 4" (3 7/8" actual) Spacing Between Pickets
- Tubing Galvanized before Fabrication
- Power Washed for Paint Preparation
- One Spray Coat High Solids Primer
- One Spray Coat Polyurethane Black
- Custom Colors Available at Additional Cost
- Choose from 14 Standard Colors — add 5%

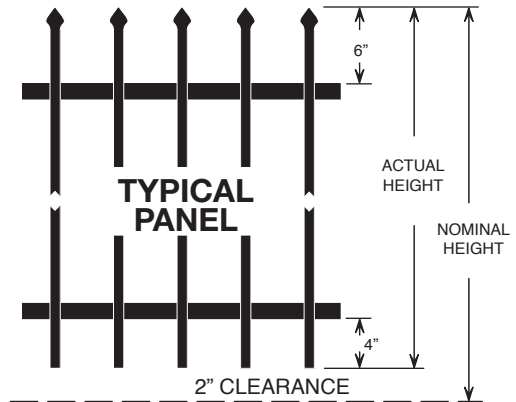

LIGHT ARISTOCRAT, Galva-Guard I, Conventional sizes PRE-GALVANIZED TUBING & POLYURETHANE PAINTED

Panels

	Nominal Height Actual Height	3' 34"	4' 46"	5' 58"	6' 70"
94" length	Item Number	69010-GI	69110-GI	69210-GI	69310-GI
	Weight in Pounds	36	44	52	60
120" length	Item Number	69020-GI	69120-GI	69220-GI	69320-GI
	Weight in Pounds	46	56	66	76
143 1/2" length	Item Number	69030-GI	69130-GI	69230-GI	69330-GI
	Weight in Pounds	54	66	78	90

Single Gates

Includes zinc plated standard hardware: an "A-Kit" and an "M-Kit"

	Nominal Height Actual Height	3' 34"	4' 46"	5' 58"	6' 70"
3' opening	Item Number	69409-GI	69419-GI	69429-GI	69439-GI
	Weight in Pounds	17	21	25	30
4' opening	Item Number	69410-GI	69420-GI	69430-GI	69440-GI
	Weight in Pounds	20	25	30	35

Double Gates

Includes zinc plated standard hardware: 2 "A-Kits" and an "R5-Kit"

	Nominal Height Actual Height	3' 34"	4' 46"	5' 58"	6' 70"
10' opening	Item Number	69449-GI	69459-GI	69469-GI	69479-GI
	Weight in Pounds	53	66	79	92
12' opening	Item Number	69450-GI	69460-GI	69470-GI	69480-GI
	Weight in Pounds	60	74	88	102

BFC Ornamental Iron LIGHT ARISTOCRAT Galva-Guard I

LIGHT ARISTOCRAT, Galva-Guard I, Non-Conventional Sizes

PANELS • Item # 69000-GI

To determine prices for non-standard sizes, use this list of "per foot" prices.

		HEIGHT						
		2'	3'	4'	5'	6'	7'	8'
per foot	-XX							

SINGLE GATES • Item # 69400-GI

Single Gates include zinc plated standard hardware: an "A-kit" and an "M-kit".

		HEIGHT						
		2'	3'	4'	5'	6'	7'	8'
WIDTH	3'							
	4'							
	5'							
	6'							
	7'							
	8'							
	9'							
	10'							

DOUBLE GATES • Item # 69455-GI

Double Gates include zinc plated standard hardware: 2 "A-kits" and an "R5-kit".

		HEIGHT						
		2'	3'	4'	5'	6'	7'	8'
WIDTH	6'							
	8'							
	10'							
	12'							
	14'							
	16'							
	18'							
	20'							

Prices are for rectangular fence and gates only.
 For BIAS fence and gates, add \$ per lineal foot.
 For TAPERED fence and gates, add \$ per lineal foot.

FOR CUSTOM OPTIONS: arching, scroll work or a wide variety of design alternatives, see the **SPECIAL PRICING APPLICATIONS** section of this catalog.

BFC Ornamental Iron HEAVY ARISTOCRAT Galva-Guard I

PICKET POSITION

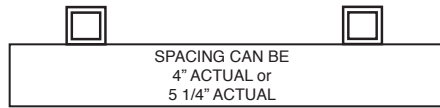

- 1 1/2" Square Top & Bottom Rail, 14 ga.
- 3/4" Square Pickets, 16 ga.
- 4" or 5 1/4" Spacing between Pickets
- Tubing Galvanized before Fabrication
- Power Washed for Paint Preparation
- One Spray Coat High Solids Primer
- One Spray Coat Polyurethane Black
- Custom Colors Available at Additional Cost
- Choose from 14 Standard Colors — add 5%

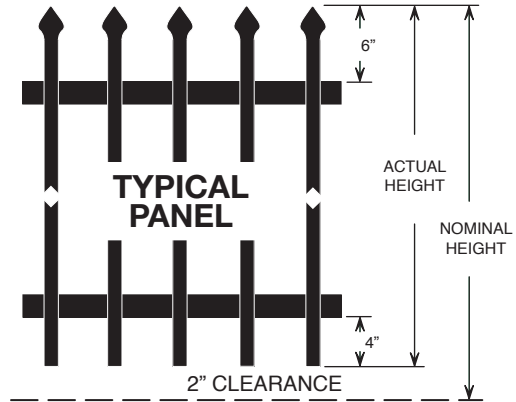

HEAVY ARISTOCRAT, Galva-Guard I, Conventional sizes PRE-GALVANIZED TUBING & POLYURETHANE PAINTED

Panels, Conventional Sizes, 4" PICKET SPACING

	Nominal Height	5'	6'	7'	8'
94" length	Item Number	80010-GI	80020-GI	80030-GI	80040-GI
	Weight in Pounds	78.4	90.4	101.6	113.6
	Price				
118" length	Item Number	80012-GI	80022-GI	80032-GI	80042-GI
	Weight in Pounds	98.0	113.0	127.0	142.0
	Price				
141 3/4" length	Item Number	80014-GI	80024-GI	80034-GI	80044-GI
	Weight in Pounds	117.6	135.6	152.4	170.4
	Price				

Panels, Conventional Sizes, 5 1/4" PICKET SPACING

	Nominal Height	5'	6'	7'	8'
94" length	Item Number	80110-GI	80120-GI	80130-GI	80140-GI
	Weight in Pounds	64.8	73.6	82.4	91.2
	Price				
118" length	Item Number	80112-GI	80122-GI	80132-GI	80142-GI
	Weight in Pounds	81.0	92.0	103.0	114.0
	Price				
141 3/4" length	Item Number	80114-GI	80124-GI	80134-GI	80144-GI
	Weight in Pounds	97.2	110.4	123.6	136.8
	Price				

Panels, Non-Conventional Sizes, per foot

	Nominal Height	5'	6'	7'	8'
4" picket spacing	Item Number	80210-GI	80220-GI	80230-GI	80240-GI
	Weight in Pounds	9.8	11.3	12.7	14.2
	Price				
5 1/4" picket spacing	Item Number	80212-GI	80222-GI	80232-GI	80242-GI
	Weight in Pounds	8.1	9.2	10.3	11.4
	Price				

BFC Ornamental Iron HEAVY ARISTOCRAT Galva-Guard I

HEAVY ARISTOCRAT, Galva-Guard I, Single Gate

Item # 80400-GI

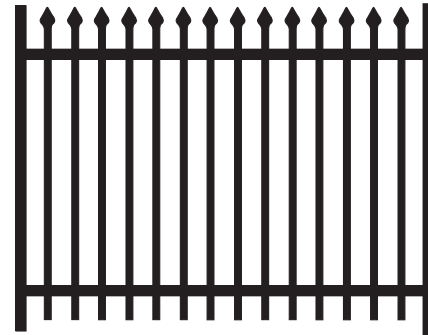
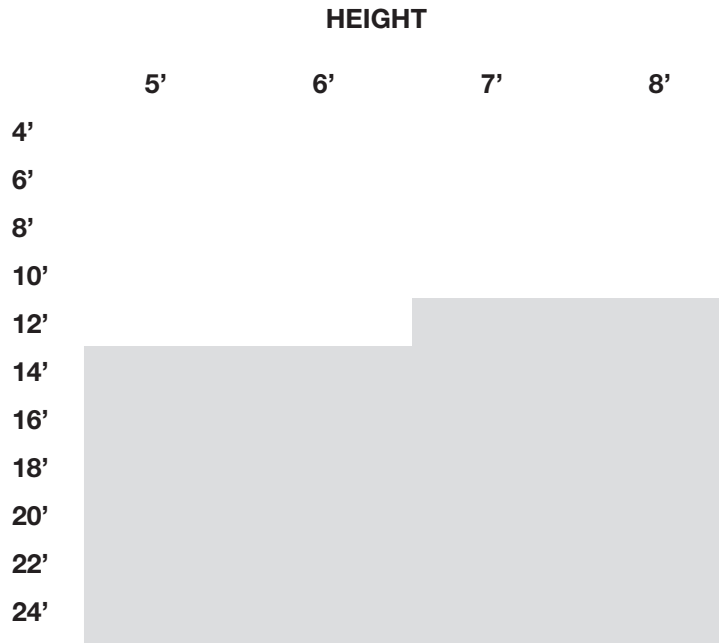

HEAVY ARISTOCRAT, Galva-Guard I, Double Gate

Item # 80450-GI

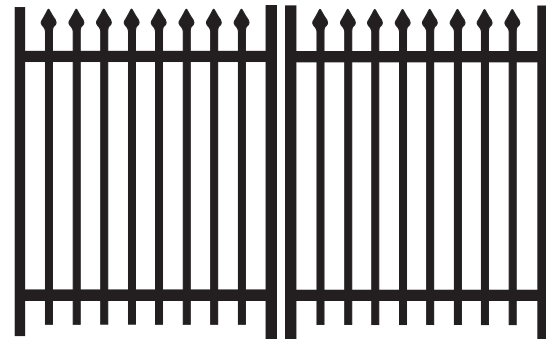
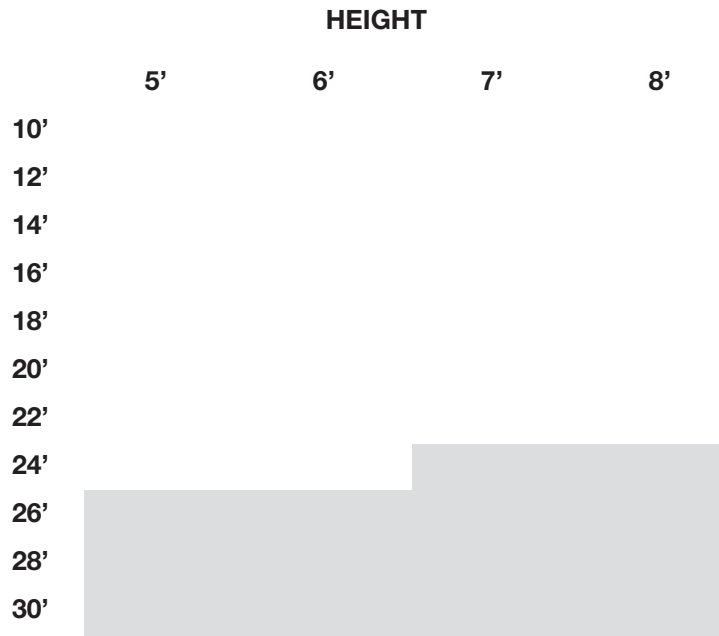

NOTES

Prices listed on this page are based on 4-inch picket spacing only and do not include hardware or trussing. Shaded areas on the pricing schedule indicate gates manufactured with a 2" frame required for additional strength.

FOR CUSTOM OPTIONS: arching, scroll work or a wide variety of design alternatives, see the **SPECIAL PRICING APPLICATIONS** section of this catalog.

Please call for special pricing.

CONVENTIONAL SLIDE GATE

GATE PRICES INCLUDE:

- 1 5/8" BFC 20 track
- 2 - P.S. pipe track wheels
- 2 - Clamp-on brackets
- 2 - P.S. caps
- 1 - 6" Rubber wheel
- Required track brackets
- Slide gate latch

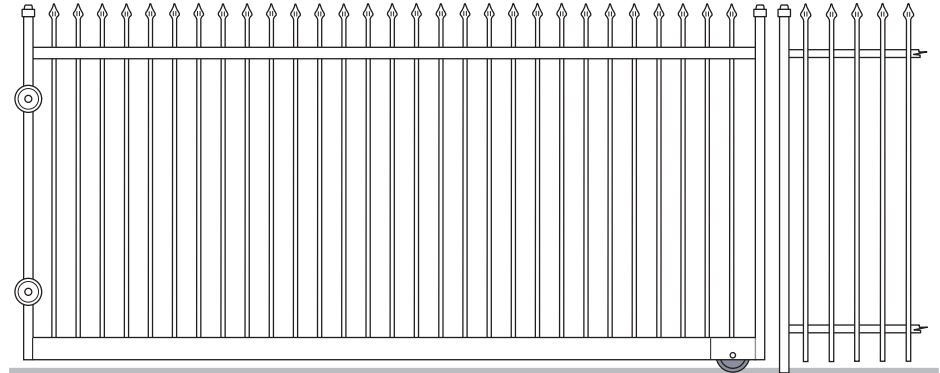

Item # 80474-GI

2" x 4" BOTTOM RAIL

Gates are manufactured with 2" top rail and sides with a 2" x 4" bottom rail (4" view), 3/4" sq. pickets and 4" picket spacing. Old style gates with square bottom rail, old style wheel boxes, and pickets on the outside of the rail are available on request.

Call for pricing on custom variations.

End View Detail



- Split Pickets
- Straighter gates because there is no welding on the outside of rails
- Wheel box part of bottom rail

Note: UL 325 requires electronically operated gates and the fence line adjoining such gates to have a maximum 2 1/8" picket spacing or mesh installed. For additional cost, contact sales person.

HEAVY ARISTOCRAT, Galva-Guard I, Conventional Slide Gate

HEIGHT

	3'	4'	5'	6'
O	8'			
P	10'			
E	12'			
N	14'			
I	16'			
N	18'			
G	20'			

FOR CUSTOM OPTIONS: arching, scroll work or a wide variety of design alternatives, see the **SPECIAL PRICING APPLICATIONS** section of this catalog.

Please call for special pricing.

BFC Ornamental Iron HEAVY ARISTOCRAT Galva-Guard I

OVERHEAD ROLLER STYLE

End View Detail

GATE PRICES INCLUDE:

- 2 - P.S. caps
- 1 - Roller assembly
- 1 - Industrial slide latch
- 2 - 6" V-Groove wheels
- Galvanized V-Track with J-bolts or tabs

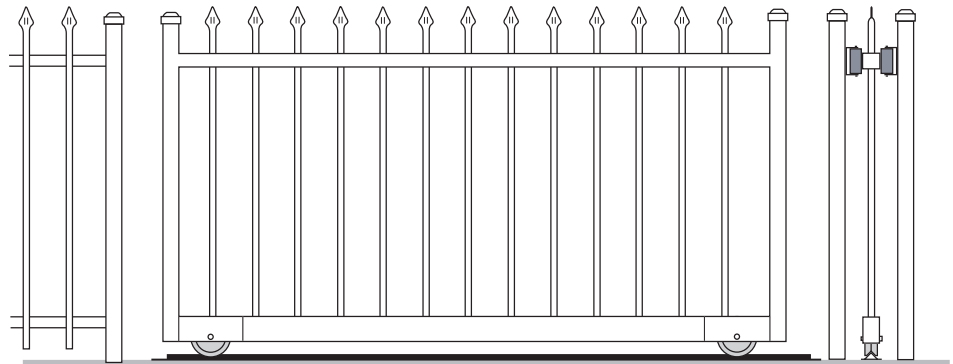

End View Detail

- Split Pickets

Item # 80475-GI

2" x 4" BOTTOM RAIL



- Straighter gates because there is no welding on the outside of rails
- No strap needed across the pickets
- Wheel box part of bottom rail

Gates are manufactured with 2" top rail and sides with a 2" x 4" bottom rail (4" view), 3/4" sq. pickets and 4" picket spacing. Old style gates with square bottom rail, old style wheel boxes, and pickets on the outside of the rail are available on request. Call for pricing on custom variations. Shaded areas on the pricing schedule indicate gates manufactured with an 11 gauge frame required for additional strength. Trussing is optional and may be required for larger gates sizes. Refer to SPECIAL PRICING APPLICATION section.

Note: UL 325 requires electronically operated gates and the fence line adjoining such gates to have a maximum 2 1/8" picket spacing or mesh installed. For additional cost, contact sales person.

HEAVY ARISTOCRAT, Galva-Guard I, Overhead Roller Assembly Style Slide Gate

		HEIGHT					
		3'	4'	5'	6'	7'	8'
	10'						
O	12'						
P	14'						
E	16'						
N	18'						
I	20'						
N	22'						
G	24'						
	26'						
	28'						
	30'						

FOR CUSTOM OPTIONS: arching, scroll work or a wide variety of design alternatives, see the **SPECIAL PRICING APPLICATIONS** section of this catalog.

Please call for special pricing.

BFC Ornamental Iron

HEAVY GUARDIAN
Galva-Guard I

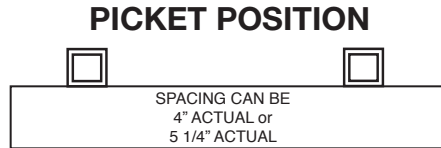

- 1 1/2" Square Top & Bottom Rail, 14 ga.
- 3/4" Square Pickets, 16 ga.
- 4" or 5 1/4" Spacing between Pickets
- Tubing Galvanized before Fabrication
- Power Washed for Paint Preparation
- One Spray Coat High Solids Primer
- One Spray Coat Polyurethane Black
- Custom Colors Available at Additional Cost
- Choose from 14 Standard Colors — add 5%

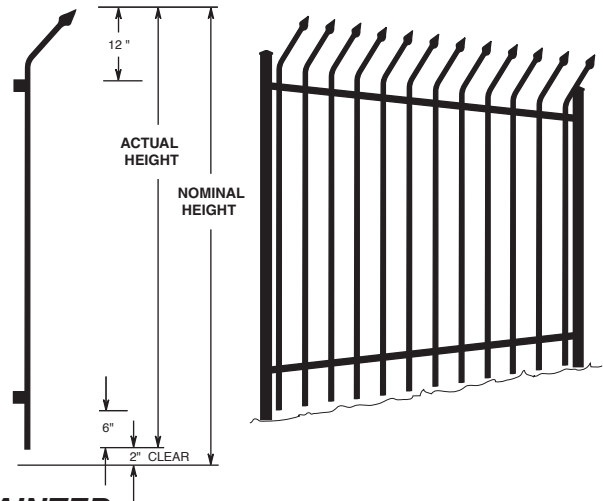

HEAVY GUARDIAN, Galva-Guard I PRE-GALVANIZED TUBING & POLYURETHANE PAINTED

Panels, Conventional Sizes, 4" PICKET SPACING

Nominal Height	7'	8'	9'	10'
94" length	Item Number: 81010-GI Weight in Pounds: 105.6 Price	Item Number: 81020-GI Weight in Pounds: 117.6 Price	Item Number: 81030-GI Weight in Pounds: 128.8 Price	Item Number: 81040-GI Weight in Pounds: 140.8 Price
118" length	Item Number: 81012-GI Weight in Pounds: 132.0 Price	Item Number: 81022-GI Weight in Pounds: 147.0 Price	Item Number: 81032-GI Weight in Pounds: 161.0 Price	Item Number: 81042-GI Weight in Pounds: 176.0 Price
141 3/4" length	Item Number: 81014-GI Weight in Pounds: 158.4 Price	Item Number: 81024-GI Weight in Pounds: 176.4 Price	Item Number: 81034-GI Weight in Pounds: 193.2 Price	Item Number: 81044-GI Weight in Pounds: 211.2 Price

Panels, Conventional Sizes, 5 1/4" PICKET SPACING

Nominal Height	7'	8'	9'	10'
94" length	Item Number: 81110-GI Weight in Pounds: 88.8 Price	Item Number: 81120-GI Weight in Pounds: 98.4 Price	Item Number: 81130-GI Weight in Pounds: 108.0 Price	Item Number: 81140-GI Weight in Pounds: 116.8 Price
118" length	Item Number: 81112-GI Weight in Pounds: 111.0 Price	Item Number: 81122-GI Weight in Pounds: 123.0 Price	Item Number: 81132-GI Weight in Pounds: 135.0 Price	Item Number: 81142-GI Weight in Pounds: 146.0 Price
141 3/4" length	Item Number: 81114-GI Weight in Pounds: 133.2 Price	Item Number: 81124-GI Weight in Pounds: 147.6 Price	Item Number: 81134-GI Weight in Pounds: 162.0 Price	Item Number: 81144-GI Weight in Pounds: 175.2 Price

Panels, Non-Conventional Sizes, per foot

Nominal Height	7'	8'	9'	10'
4" picket spacing	Item Number: 81210-GI Weight in Pounds: 13.2 Price	Item Number: 81220-GI Weight in Pounds: 14.7 Price	Item Number: 81230-GI Weight in Pounds: 16.1 Price	Item Number: 81240-GI Weight in Pounds: 17.6 Price
5 1/4" picket spacing	Item Number: 81212-GI Weight in Pounds: 11.1 Price	Item Number: 81222-GI Weight in Pounds: 12.3 Price	Item Number: 81232-GI Weight in Pounds: 13.5 Price	Item Number: 81242-GI Weight in Pounds: 14.6 Price

The shaded items are too large to be Factory painted, they are furnished not cleaned of mill oil and not painted.

HEAVY GUARDIAN, Galva-Guard I, Single Gate

Item # 81400-GI

		HEIGHT			
		7'	8'	9'	* 10'
4'					
6'					
8'					
10'					*
12'					*
14'					*
16'					*
18'					*
20'					*
22'					*
24'					*

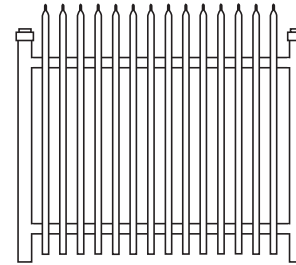

HEAVY GUARDIAN, Galva-Guard I, Double Gate

Item # 81450-GI

		HEIGHT			
		7'	8'	9'	* 10'
10'					
12'					
14'					
16'					
18'					
20'					*
22'					*
24'					*
26'					*
28'					*
30'					*

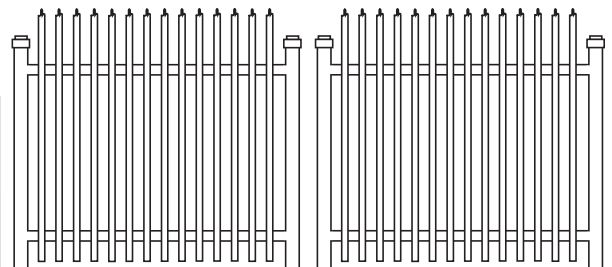

NOTES

Prices listed on this page are based on 4-inch picket spacing only and do not include hardware or trussing. Shaded areas on the pricing schedule indicate gates manufactured with a 2" frame required for additional strength.

FOR CUSTOM OPTIONS: arching, scroll work or a wide variety of design alternatives, see the **SPECIAL PRICING APPLICATIONS** section of this catalog.

* All 10' Guardian swing gates over 9' in width are too large to be factory painted. They are furnished not cleaned of mill oil and not painted.

CONVENTIONAL SLIDE GATE

GATE PRICES INCLUDE:

- 1 5/8" BFC 20 track
- 2 - P.S. pipe track wheels
- 2 - Clamp-on brackets
- 2 - P.S. caps
- 1 - 6" Rubber wheel
- Required track brackets
- Slide gate latch

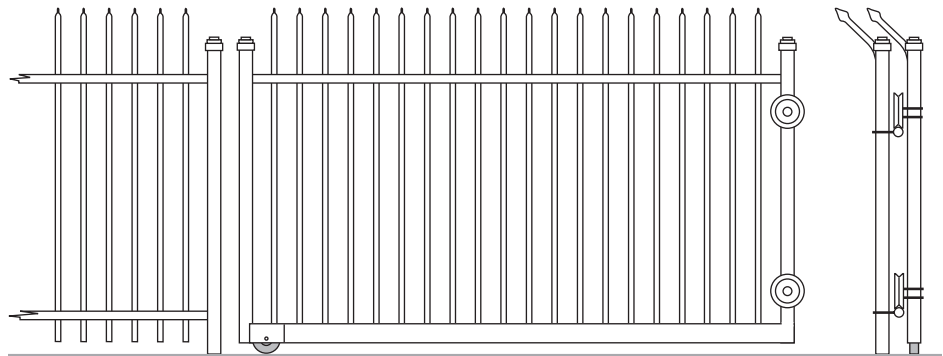

Item # 81474-GI

2" x 4" BOTTOM RAIL

Gates are manufactured with 2" top rail and sides with a 2" x 4" bottom rail (4" view), 3/4" sq. pickets and 4" picket spacing. Old style gates with square bottom rail, old style wheel boxes, and pickets on the outside of the rail are available on request.

Call for pricing on custom variations.

End View Detail

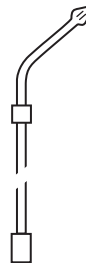

- Split Pickets
- Straighter gates because there is no welding on the outside of rails
- Wheel box part of bottom rail

Note: UL 325 requires electronically operated gates and the fence line adjoining such gates to have a maximum 2 1/8" picket spacing or mesh installed. For additional cost, contact sales person.

HEAVY GUARDIAN, Galva-Guard I, Conventional Slide Gate

		HEIGHT		
O		7'	8'	9'
P				
E	10'			
N	12'			
I	14'			
N	16'			
G				

FOR CUSTOM OPTIONS: arching, scroll work or a wide variety of design alternatives, see the **SPECIAL PRICING APPLICATIONS** section of this catalog.

Please call for special pricing.

OVERHEAD ROLLER STYLE

GATE PRICES INCLUDE:

- 2 - P.S. caps
- 1 - Roller assembly
- 1 - Industrial slide latch
- 2 - 6" V-Groove wheels
- Galvanized V-Track with J-bolts or tabs

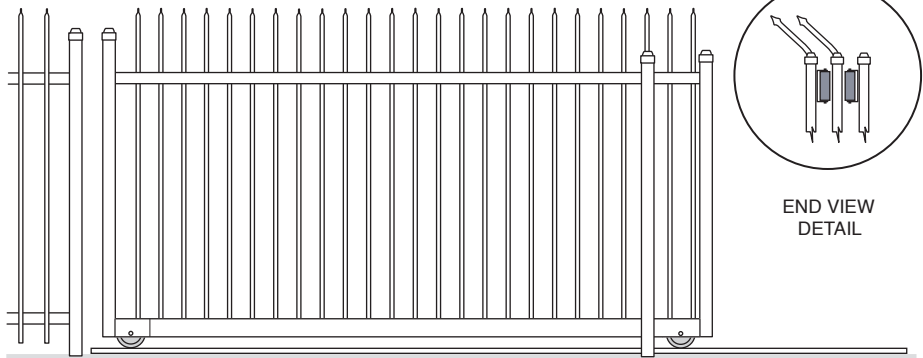

END VIEW
DETAIL

End View Detail

- Split Pickets
- Straighter gates because there is no welding on the outside of rails
- No strap needed across the pickets
- Wheel box part of bottom rail

Item # 81475-GI

2" x 4" BOTTOM RAIL

Gates are manufactured with 2" top rail and sides with a 2" x 4" bottom rail (4" view), 3/4" sq. pickets and 4" picket spacing. Old style gates with square bottom rail, old style wheel boxes, and pickets on the outside of the rail are available on request. Call for pricing on custom variations. Shaded areas on the pricing schedule indicate gates manufactured with an 11 gauge frame required for additional strength. Trussing is optional and may be required for larger gates sizes. Refer to SPECIAL PRICING APPLICATION section.

Note: UL 325 requires electronically operated gates and the fence line adjoining such gates to have a maximum 2 1/8" picket spacing or mesh installed. For additional cost, contact sales person.

HEAVY GUARDIAN, Galva-Guard I, Overhead Roller Assembly Style Slide Gate

		HEIGHT			
		7'	8'	9'	* 10'
	10'				*
O	12'				*
P	14'				*
E	16'				*
N	18'				*
I	20'				*
N	22'				*
G	24'				*
	26'				*
	28'				*
	30'				*

* All 10' Guardian slide gates over 9' in width are too large to be factory painted. They are furnished not cleaned of mill oil and not painted.

FOR CUSTOM OPTIONS: arching, scroll work or a wide variety of design alternatives, see the **SPECIAL PRICING APPLICATIONS** section of this catalog.

BFC Ornamental Iron

LIGHT REGAL
Powder Coat

PANELS

PICKET POSITION

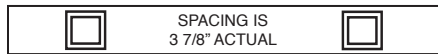

- 1" Square Top & Bottom Rail, 16 ga.
- 5/8" Square Pickets, 18 ga.
- 4" (3 7/8" actual) Spacing between Pickets
- Powder Coat Black

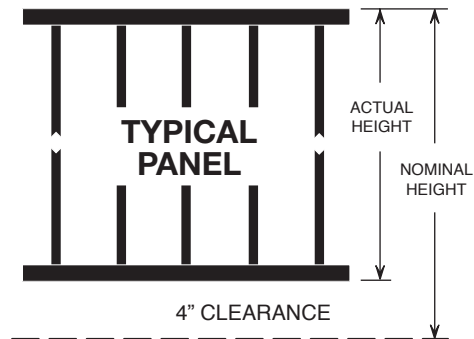

LIGHT REGAL, POWDER COAT For Pre-Galvanized add 35%

Panels

	Nominal Height Actual Height	3' 32"	3 1/2' 38"	4' 44"	SPECIAL 58"	6' 68"
94" length	Item Number	68010-PC	68040-PC	68110-PC	68240-PC	68310-PC
	Weight in Pounds	33	37	41	51	57
	Price					
120" length	Item Number	68020-PC	68050-PC	68120-PC	68250-PC	68320-PC
	Weight in Pounds	42	47	52	64	72
	Price					

PANELS

PICKET POSITION

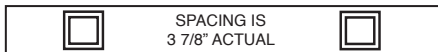

- 1" Square Top & Bottom Rail, 16 ga.
- 5/8" Square Pickets, 18 ga.
- 4" (3 7/8" actual) Spacing between Pickets
- Powder Coat Black

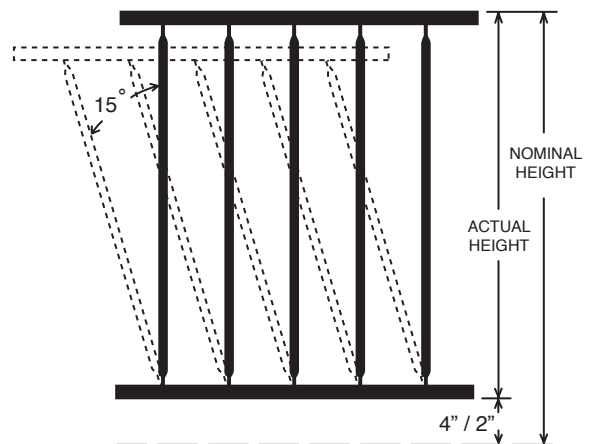

LIGHT REGAL, POWDER COAT BIASABLE

Panels

	Nominal Height Actual Height	3' 32"	3 1/2' 38"	4' 44"	SPECIAL 58"	6' 68"
94" length	Item Number	77010-PC	77041-PC	77110-PC	77240-PC	77310-PC
	Weight in Pounds	33	37	41	51	57
	Price					
120" length	Item Number	77020-PC	77042-PC	77120-PC	77250-PC	77320-PC
	Weight in Pounds	42	47	52	64	72
	Price					

BFC Ornamental Iron LIGHT ARISTOCRAT Powder Coat

PANELS

PICKET POSITION

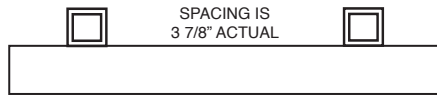

- 1" Square Top & Bottom Rail, 16 ga.
- 5/8" Square Pickets, 18 ga.
- 4 1/2" O.C. (3 7/8" actual) Spacing Between Pickets
- Powder Coat Black

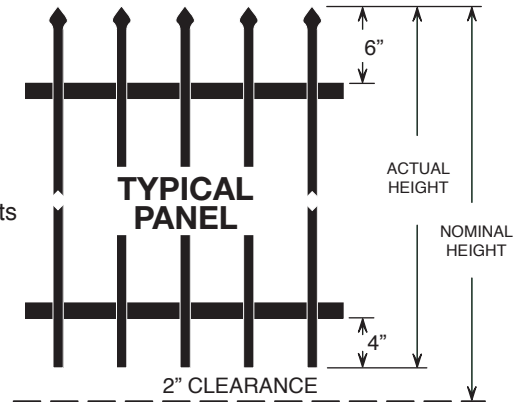

LIGHT ARISTOCRAT, POWDER COAT
 Biasable available at no extra charge
 For Pre-Galvanized add 35%

Panels

	Nominal Height Actual Height	3' 34"	4' 46"	5' 58"	6' 70"
94" length	Item Number	69010-PC	69110-PC	69210-PC	69310-PC
	Weight in Pounds	36	44	52	60
120" length	Item Number	69020-PC	69120-PC	69220-PC	69320-PC
	Weight in Pounds	46	56	66	76

POWDER COATED

POST PRICES

PRESSED STEEL CAP INCLUDED

2" SQ POSTS

14 GA

Post Length	Item#	Size	Price
6'	82300PC-072	2" x 6'	
7'	82300PC-084	2" x 7'	
8'	82300PC-096	2" x 8'	
9'	82300PC-108	2" x 9'	

LBS/FT **1.87**

3" SQ POSTS

11 GA

Post Length	Item#	Size	Price
8'	82550PC-096	3" x 8'	
9'	82550PC-108	3" x 9'	

LBS/FT **4.57**

GATE SIDES

2 1/2" SQ POSTS

11 GA

Post Length	Item#	Size	Price
8'	82500PC-096	2 1/2" x 8'	
9'	82500PC-108	2 1/2" x 9'	

LBS/FT **3.76**

1" GATE SIDES

16 GA

Height	Item#	Size	Price
58 3/4"	82950PC-058	5' x 1" 16 GA	
68 3/4"	82950PC-058	6' x 1" 16 GA	

LBS/FT **.767**

PICKET POSITION

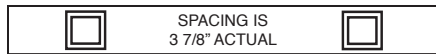

- 1" Square Top & Bottom Rail, 16 ga.
- 5/8" Square Pickets, 18 ga.
- 4" (3 7/8" actual) Spacing between Pickets
- Power Washed for Paint Preparation
- One Shop Prime Coat
- One Top Coat Black Enamel

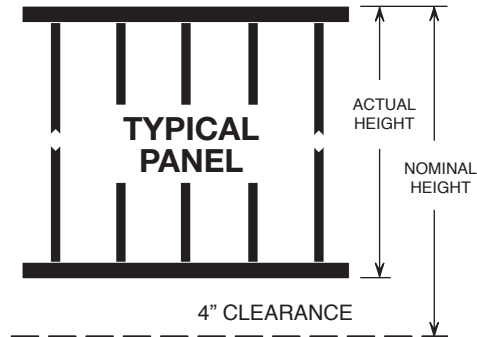

LIGHT REGAL, Two Coat, Conventional Sizes

For black polyurethane top coat add 10% to these prices
For pre-galvanized rail & pickets add 45% to these prices

Panels

	Nominal Height Actual Height	3' 32"	3 1/2' 38"	4' 44"	5' 56"	SPECIAL 58"	6' 68"
94" length	Item Number	68010-D	68040-D	68110-D	68210-D	68240-D	68310-D
	Weight in Pounds	33	37	41	49	51	57
120" length	Item Number	68020-D	68050-D	68120-D	68220-D	68250-D	68320-D
	Weight in Pounds	42	47	52	62	64	72
143 1/2" length	Item Number	68030-D	68060-D	68130-D	68230-D	68260-D	68330-D
	Weight in Pounds	50	56	62	74	77	86

Single Gates

Includes standard hardware: an "A-Kit" and an "M-Kit"

	Nominal Height Actual Height	3' 32"	3 1/2' 38"	4' 44"	5' 56"	SPECIAL 58"	6' 68"
3' opening	Item Number	68409-D	68414-D	68419-D	68429-D	68435-D	68439-D
	Weight in Pounds	16	18	20	24	25	29
4' opening	Item Number	68410-D	68415-D	68420-D	68430-D	68436-D	68440-D
	Weight in Pounds	19	22	24	29	31	34

Double Gates

Includes standard hardware: 2 "A-Kits" and an "R5-Kit"

	Nominal Height Actual Height	3' 32"	3 1/2' 38"	4' 44"	5' 56"	SPECIAL 58"	6' 68"
10' opening	Item Number	68449-D	68454-D	68459-D	68469-D	68485-D	68479-D
	Weight in Pounds	49	56	62	75	78	88
12' opening	Item Number	68450-D	68455-D	68460-D	68470-D	68487-D	68480-D
	Weight in Pounds	56	63	70	84	87	98

BFC Ornamental Iron

LIGHT REGAL
Two Coat

LIGHT REGAL, Two Coat, Non-Conventional Sizes

PANELS • Item # 68000-D

To determine prices for non-standard sizes, use this list of "per foot" prices.

		HEIGHT							
		2'	3'	3 1/2'	4'	5'	6'	7'	8'
per foot	-XX								

SINGLE GATES • Item # 68400-D

Single Gates include standard hardware: an "A-kit" and an "M-kit".

		HEIGHT							
		2'	3'	3 1/2'	4'	5'	6'	7'	8'
WIDTH	3'								
	4'								
	5'								
	6'								
	7'								
	8'								
	9'								
	10'								

DOUBLE GATES • Item # 68455-D

Double Gates include standard hardware: 2 "A-kits" and an "R5-kit".

		HEIGHT							
		2'	3'	3 1/2'	4'	5'	6'	7'	8'
WIDTH	6'								
	8'								
	10'								
	12'								
	14'								
	16'								
	18'								
	20'								

Prices are for rectangular fence and gates only.
For BIAS fence and gates, add \$ per lineal foot.
For TAPERED fence and gates, add \$ per lineal foot.

FOR CUSTOM OPTIONS: arching, scroll work or a wide variety of design alternatives, see the **SPECIAL PRICING APPLICATIONS** section of this catalog.

PICKET POSITION

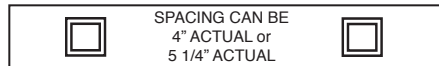

- 1 1/2" Square Top & Bottom Rail, 14 ga.
- 3/4" Square Pickets, 16 ga.
- 4" or 5 1/4" Spacing between Pickets
- Power Washed for Paint Preparation
- One Shop Prime Coat
- One Top Coat Black Enamel

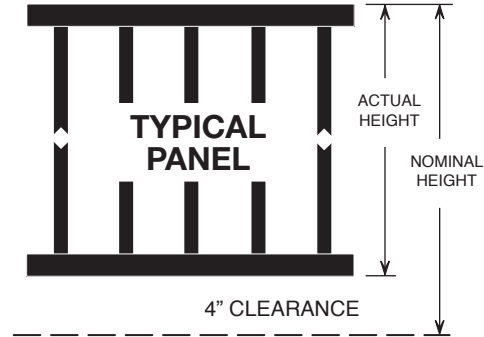

HEAVY REGAL, Two Coat

For black polyurethane top coat add 10% to these prices
For pre-galvanized rail & pickets add 35% to these prices

Panels, Conventional Sizes, 4" PICKET SPACING

Nominal Height	5'	6'	7'	8'	
94" length	Item Number	79010-D	79020-D	79030-D	79040-D
	Weight in Pounds	74.4	86.4	97.6	109.6
	Price				
118" length	Item Number	79012-D	79022-D	79032-D	79042-D
	Weight in Pounds	93	108	122	137
	Price				
141 3/4" length	Item Number	79014-D	79024-D	79034-D	79044-D
	Weight in Pounds	111.6	129.6	146.4	164.4
	Price				

Panels, Conventional Sizes, 5 1/4" PICKET SPACING

Nominal Height	5'	6'	7'	8'	
94" length	Item Number	79110-D	79120-D	79130-D	79140-D
	Weight in Pounds	61.6	70.4	78.4	88
	Price				
118" length	Item Number	79112-D	79122-D	79132-D	79142-D
	Weight in Pounds	77	88	98	111
	Price				
141 3/4" length	Item Number	79114-D	79124-D	79134-D	79144-D
	Weight in Pounds	92.4	105.6	117.6	132
	Price				

Panels, Non-Conventional Sizes, per foot

Nominal Height	5'	6'	7'	8'	
4" picket spacing	Item Number	79210-D	79220-D	79230-D	79240-D
	Weight in Pounds	9.3	10.8	12.2	13.7
	Price				
5 1/4" picket spacing	Item Number	79212-D	79222-D	79232-D	79242-D
	Weight in Pounds	7.7	8.8	9.9	11
	Price				

HEAVY REGAL, Two Coat, Single Gate

Item # 79400-D

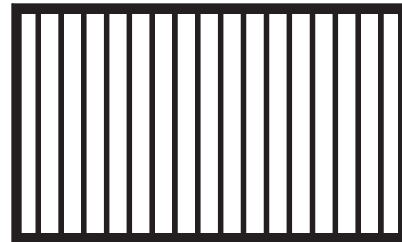
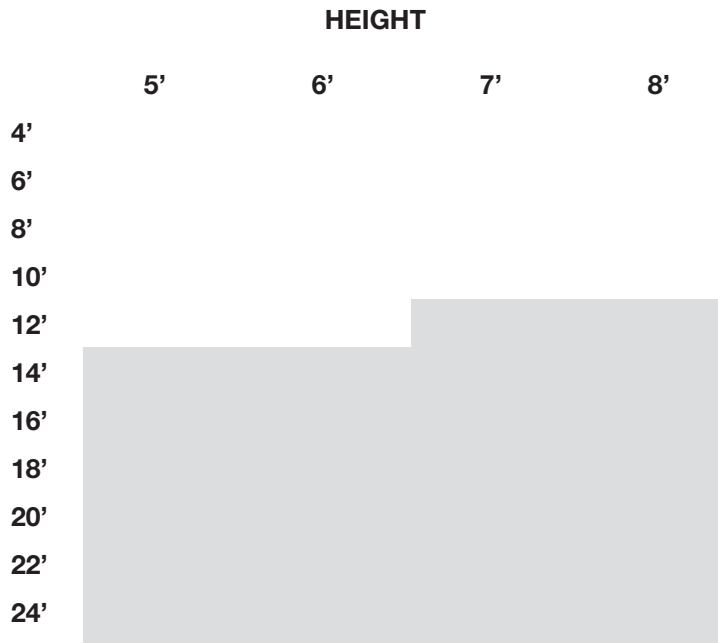

HEAVY REGAL, Two Coat, Double Gate

Item # 79450-D

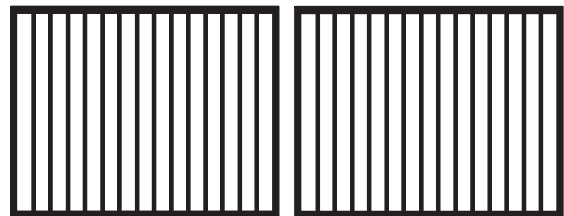
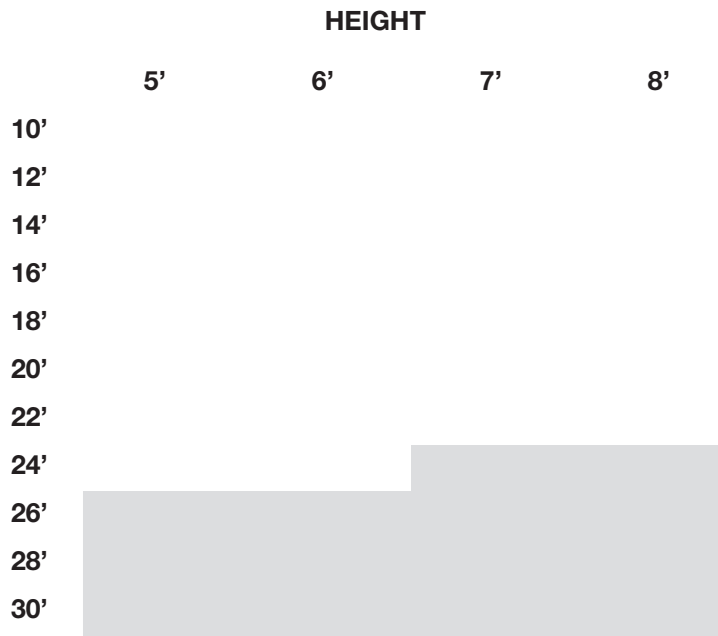

NOTES

Prices listed on this page are based on 4-inch picket spacing only and do not include hardware or trussing. Shaded areas on the pricing schedule indicate gates manufactured with a 2" frame required for additional strength.

FOR CUSTOM OPTIONS: arching, scroll work or a wide variety of design alternatives, see the **SPECIAL PRICING APPLICATIONS** section of this catalog.

Please call for special pricing.

CONVENTIONAL SLIDE GATE

GATE PRICES INCLUDE:

- 1 5/8" BFC 20 track
- 2 - P.S. pipe track wheels
- 2 - Clamp-on brackets
- 2 - P.S. caps
- 1 - 6" Rubber wheel
- Required track brackets
- Slide gate latch

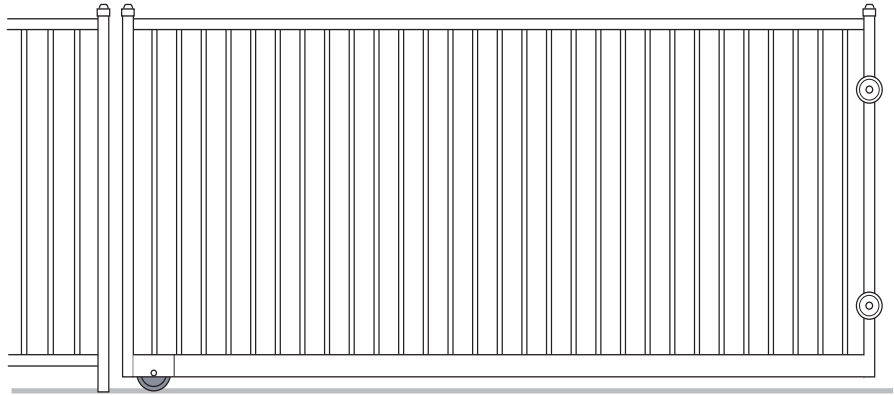

Item # 79474-D

2" x 4" BOTTOM RAIL

Gates are manufactured with 2" top rail and sides with a 2" x 4" bottom rail (4" view), 3/4" sq. pickets and 4" picket spacing. Old style gates with square bottom rail and old style wheel boxes are available upon request.

Note: Ground clearance reduced to 2". Call for pricing on custom variations.

Note: UL 325 requires electronically operated gates and the fence line adjoining such gates to have a maximum 2 1/8" picket spacing or mesh installed. For additional cost, contact sales person.

HEAVY REGAL, Two Coat, Conventional Slide Gate

HEIGHT

	3'	4'	5'	6'
O	8'			
P	10'			
E	12'			
N	14'			
I	16'			
N	18'			
G	20'			

FOR CUSTOM OPTIONS: arching, scroll work or a wide variety of design alternatives, see the **SPECIAL PRICING APPLICATIONS** section of this catalog.

Please call for special pricing.

BFC Ornamental Iron LIGHT ARISTOCRAT Two Coat



- 1" Square Top & Bottom Rail, 16 ga.
- 5/8" Square Pickets, 18 ga.
- 4" (3 7/8" actual) Spacing Between Pickets
- Power Washed for Paint Preparation
- One Shop Prime Coat
- One Top Coat Black Enamel

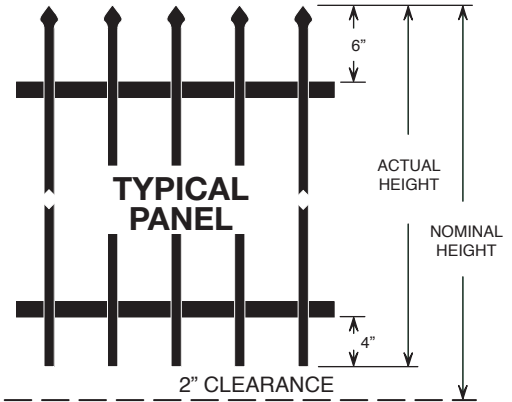

LIGHT ARISTOCRAT, Two Coat, Conventional Sizes

*For black polyurethane top coat add 10% to these prices
For pre-galvanized rail & pickets add 45% to these prices*

Panels

	Nominal Height Actual Height	3' 34"	4' 46"	5' 58"	6' 70"
94" length	Item Number	69010-D	69110-D	69210-D	69310-D
	Weight in Pounds	36	44	52	60
	Price				
120" length	Item Number	69020-D	69120-D	69220-D	69320-D
	Weight in Pounds	46	56	66	76
	Price				
143 1/2" length	Item Number	69030-D	69130-D	69230-D	69330-D
	Weight in Pounds	54	66	78	90
	Price				

Single Gates

Includes standard hardware: an "A-Kit" and an "M-Kit"

	Nominal Height Actual Height	3' 34"	4' 46"	5' 58"	6' 70"
3' opening	Item Number	69409-D	69419-D	69429-D	69439-D
	Weight in Pounds	17	21	25	30
	Price				
4' opening	Item Number	69410-D	69420-D	69430-D	69440-D
	Weight in Pounds	20	25	30	35
	Price				

Double Gates

Includes standard hardware: 2 "A-Kits" and an "R5-Kit"

	Nominal Height Actual Height	3' 34"	4' 46"	5' 58"	6' 70"
10' opening	Item Number	69449-D	69459-D	69469-D	69479-D
	Weight in Pounds	53	66	79	92
	Price				
12' opening	Item Number	69450-D	69460-D	69470-D	69480-D
	Weight in Pounds	60	74	88	102
	Price				

BFC Ornamental Iron LIGHT ARISTOCRAT Two Coat

LIGHT ARISTOCRAT, Two Coat, Non-Conventional Sizes

PANELS • Item # 69000-D

To determine prices for non-standard sizes, use this list of "per foot" prices.

		HEIGHT						
		2'	3'	4'	5'	6'	7'	8'
per foot	-XX							

SINGLE GATES • Item # 69400-D

Single Gates include standard hardware: an "A-kit" and an "M-kit".

		HEIGHT						
		2'	3'	4'	5'	6'	7'	8'
WIDTH	3'							
	4'							
	5'							
	6'							
	7'							
	8'							
	9'							
	10'							

DOUBLE GATES • Item # 69455-D

Double Gates include standard hardware: 2 "A-kits" and an "R5-kit".

		HEIGHT						
		2'	3'	4'	5'	6'	7'	8'
WIDTH	6'							
	8'							
	10'							
	12'							
	14'							
	16'							
	18'							
	20'							

Prices are for rectangular fence and gates only.

For BIAS fence and gates, add \$ per lineal foot.

For TAPERED fence and gates, add \$ per lineal foot.

FOR CUSTOM OPTIONS: arching, scroll work or a wide variety of design alternatives, see the **SPECIAL PRICING APPLICATIONS** section of this catalog.

BFC Ornamental Iron HEAVY ARISTOCRAT Two Coat



- 1 1/2" Square Top & Bottom Rail, 14 ga.
- 3/4" Square Pickets, 16 ga.
- 4" or 5 1/4" Spacing between Pickets
- Power Washed for Paint Preparation
- One Shop Prime Coat
- One Top Coat Black Enamel

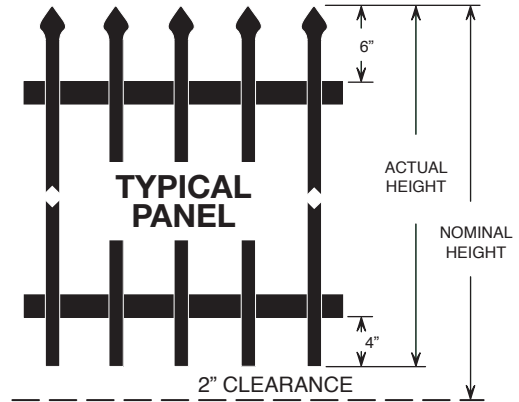

HEAVY ARISTOCRAT, Two Coat,

*For black polyurethane top coat add 10% to these prices
For pre-galvanized rail & pickets add 35% to these prices*

Panels, Conventional Sizes, 4" PICKET SPACING

Nominal Height	5'	6'	7'	8'
94" length				
Item Number	80010-D	80020-D	80030-D	80040-D
Weight in Pounds	78.4	90.4	101.6	113.6
Price				
118" length				
Item Number	80012-D	80022-D	80032-D	80042-D
Weight in Pounds	98.0	113.0	127.0	142.0
Price				
141 3/4" length				
Item Number	80014-D	80024-D	80034-D	80044-D
Weight in Pounds	117.6	135.6	152.4	170.4
Price				

Panels, Conventional Sizes, 5 1/4" PICKET SPACING

Nominal Height	5'	6'	7'	8'
94" length				
Item Number	80110-D	80120-D	80130-D	80140-D
Weight in Pounds	64.8	73.6	82.4	91.2
Price				
118" length				
Item Number	80112-D	80122-D	80132-D	80142-D
Weight in Pounds	81.0	92.0	103.0	114.0
Price				
141 3/4" length				
Item Number	80114-D	80124-D	80134-D	80144-D
Weight in Pounds	97.2	110.4	123.6	136.8
Price				

Panels, Non-Conventional Sizes, per foot

Nominal Height	5'	6'	7'	8'
4" picket spacing				
Item Number	80210-D	80220-D	80230-D	80240-D
Weight in Pounds	9.8	11.3	12.7	14.2
Price				
5 1/4" picket spacing				
Item Number	80212-D	80222-D	80232-D	80242-D
Weight in Pounds	8.1	9.2	10.3	11.4
Price				

BFC Ornamental Iron HEAVY ARISTOCRAT Two Coat

HEAVY ARISTOCRAT, Two Coat, Single Gate

Item # 80400-D

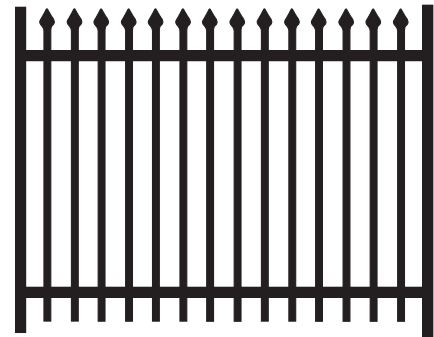
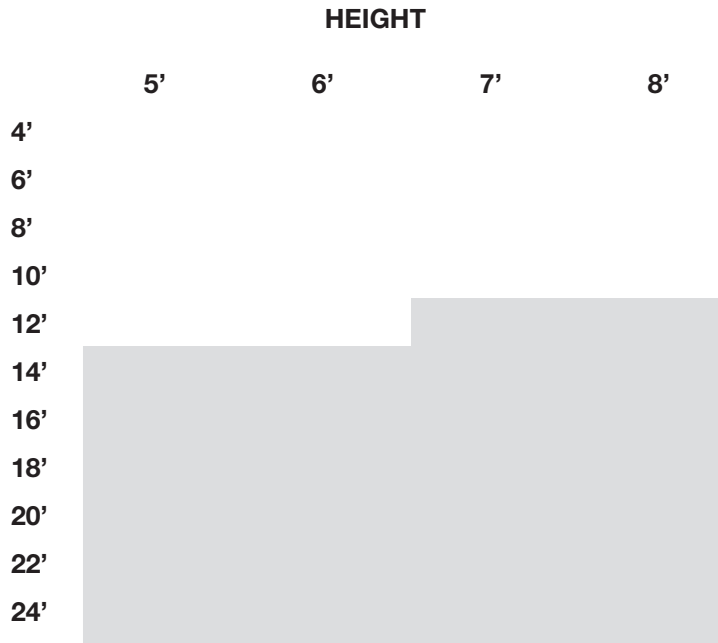

HEAVY ARISTOCRAT, Two Coat, Double Gate

Item # 80450-D

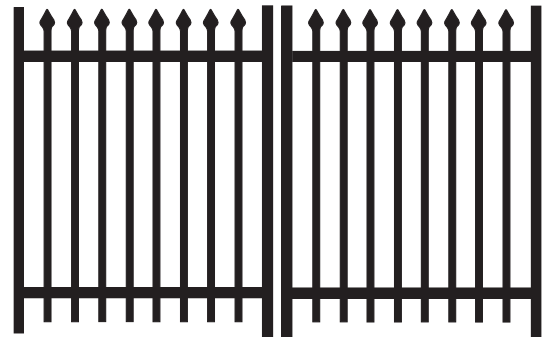
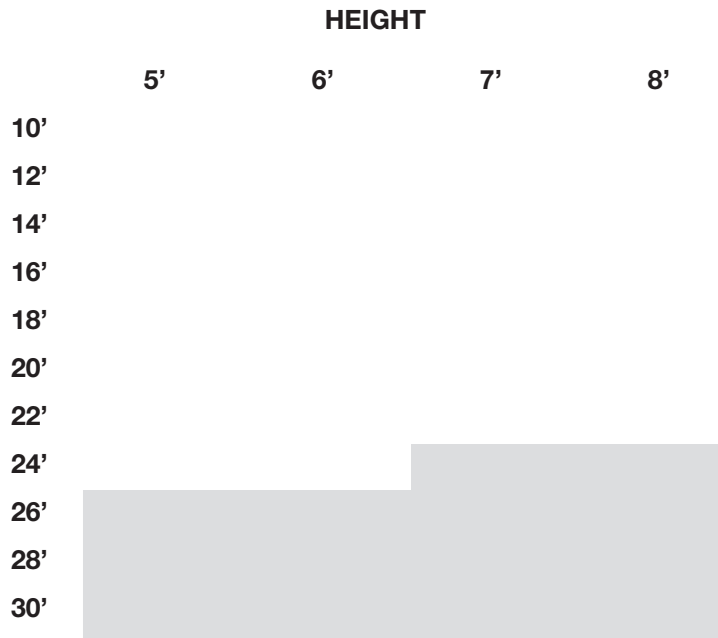

NOTES

Prices listed on this page are based on 4-inch picket spacing only and do not include hardware or trussing. Shaded areas on the pricing schedule indicate gates manufactured with a 2" frame required for additional strength.

FOR CUSTOM OPTIONS: arching, scroll work or a wide variety of design alternatives, see the **SPECIAL PRICING APPLICATIONS** section of this catalog.

Please call for special pricing.

BFC Ornamental Iron HEAVY ARISTOCRAT Two Coat

CONVENTIONAL SLIDE GATE

GATE PRICES INCLUDE:

- 1 5/8" BFC 20 track
- 2 - P.S. pipe track wheels
- 2 - Clamp-on brackets
- 2 - P.S. caps
- 1 - 6" Rubber wheel
- Required track brackets
- Slide gate latch

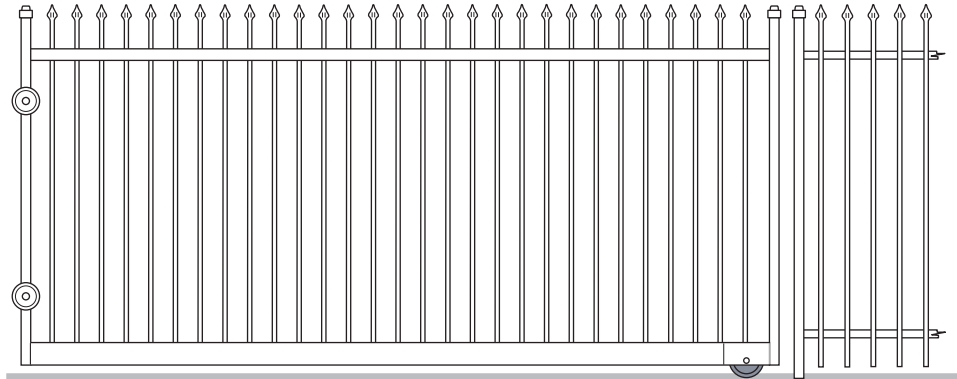

Item # 80474-D

2" x 4" BOTTOM RAIL

Gates are manufactured with 2" top rail and sides with a 2" x 4" bottom rail (4" view), 3/4" sq. pickets and 4" picket spacing. Old style gates with square bottom rail, old style wheel boxes, and pickets on the outside of the rail are available on request.

Call for pricing on custom variations.

End View Detail



- Split Pickets
- Straighter gates because there is no welding on the outside of rails
- Wheel box part of bottom rail

Note: UL 325 requires electronically operated gates and the fence line adjoining such gates to have a maximum 2 1/8" picket spacing or mesh installed. For additional cost, contact sales person.

HEAVY ARISTOCRAT, Two Coat, Conventional Slide Gate

HEIGHT

	3'	4'	5'	6'
O	8'			
P	10'			
E	12'			
N	14'			
I	16'			
N	18'			
G	20'			

FOR CUSTOM OPTIONS: arching, scroll work or a wide variety of design alternatives, see the **SPECIAL PRICING APPLICATIONS** section of this catalog.

Please call for special pricing.

BFC Ornamental Iron HEAVY ARISTOCRAT Two Coat

OVERHEAD ROLLER STYLE

End View
Detail

GATE PRICES INCLUDE:

- 2 - P.S. caps
- 1 - Roller assembly
- 1 - Industrial slide latch
- 2 - 6" V-Groove wheels
- V-Track with J-bolts or Tabs

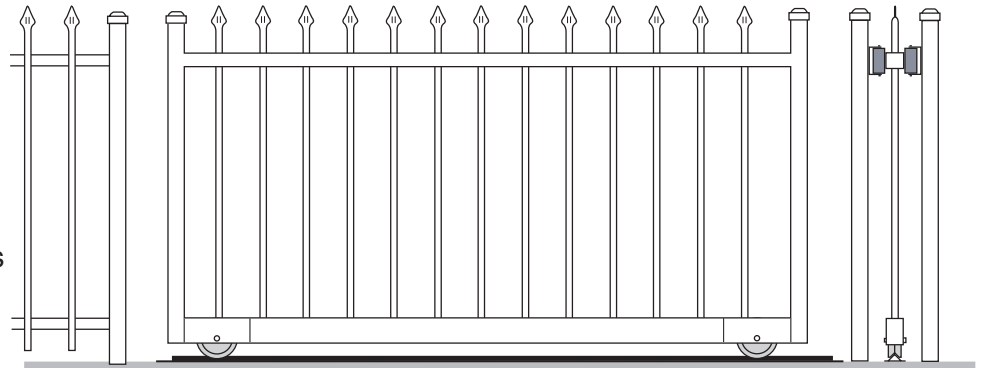

End View Detail

- Split Pickets

Item # 80475-D

2" x 4" BOTTOM RAIL



- Straighter gates because there is no welding on the outside of rails
- No strap needed across the pickets
- Wheel box part of bottom rail

Gates are manufactured with 2" top rail and sides with a 2" x 4" bottom rail (4" view), 3/4" sq. pickets and 4" picket spacing. Old style gates with square bottom rail, old style wheel boxes, and pickets on the outside of the rail are available on request. Call for pricing on custom variations. Shaded areas on the pricing schedule indicate gates manufactured with an 11 gauge frame required for additional strength. Trussing is optional and may be required for larger gates sizes. Refer to SPECIAL PRICING APPLICATION section.

Note: UL 325 requires electronically operated gates and the fence line adjoining such gates to have a maximum 2 1/8" picket spacing or mesh installed. For additional cost, contact sales person.

HEAVY ARISTOCRAT, Two Coat, Overhead Roller Assembly Style Slide Gate

		HEIGHT					
		3'	4'	5'	6'	7'	8'
	10'						
O	12'						
P	14'						
E	16'						
N	18'						
I	20'						
N	22'						
G	24'						
	26'						
	28'						
	30'						

FOR CUSTOM OPTIONS: arching, scroll work or a wide variety of design alternatives, see the **SPECIAL PRICING APPLICATIONS** section of this catalog.

Please call for special pricing.

BFC Ornamental Iron

HEAVY GUARDIAN
Two Coat

PICKET POSITION

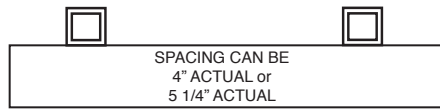

- 1 1/2" Square Top & Bottom Rail, 14 ga.
- 3/4" Square Pickets, 16 ga.
- 4" or 5 1/4" Spacing between Pickets
- Power Washed for Paint Preparation
- One Shop Prime Coat
- One Top Coat Black Enamel

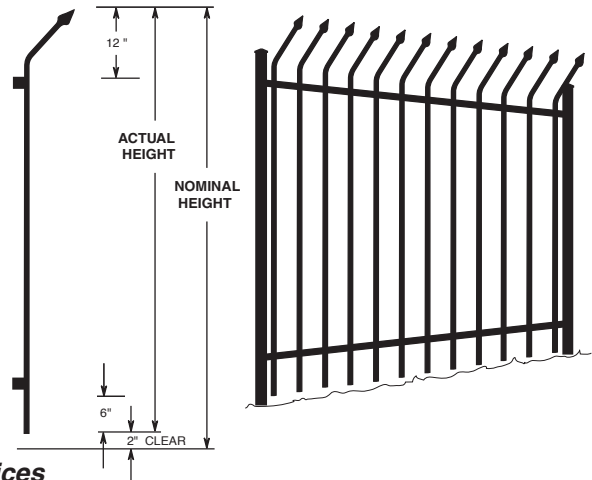

HEAVY GUARDIAN, Two Coat,

*For black polyurethane top coat add 10% to these prices
For pre-galvanized rail & pickets add 35% to these prices*

Panels, Conventional Sizes, 4" PICKET SPACING

	Nominal Height	7'	8'	9'	10'
94" length	Item Number	81010-D	81020-D	81030-D	81040-D
	Weight in Pounds	105.6	117.6	128.8	140.8
	Price				
118" length	Item Number	81012-D	81022-D	81032-D	81042-D
	Weight in Pounds	132.0	147.0	161.0	176.0
	Price				
141 3/4" length	Item Number	81014-D	81024-D	81034-D	81044-D
	Weight in Pounds	158.4	176.4	193.2	211.2
	Price				

Panels, Conventional Sizes, 5 1/4" PICKET SPACING

	Nominal Height	7'	8'	9'	10'
94" length	Item Number	81110-D	81120-D	81130-D	81140-D
	Weight in Pounds	88.8	98.4	108.0	116.8
	Price				
118" length	Item Number	81112-D	81122-D	81132-D	81142-D
	Weight in Pounds	111.0	123.0	135.0	146.0
	Price				
141 3/4" length	Item Number	81114-D	81124-D	81134-D	81144-D
	Weight in Pounds	133.2	147.6	162.0	175.2
	Price				

Panels, Non-Conventional Sizes, per foot

	Nominal Height	7'	8'	9'	10'
4" picket spacing	Item Number	81210-D	81220-D	81230-D	81240-D
	Weight in Pounds	13.2	14.7	16.1	17.6
	Price				
5 1/4" picket spacing	Item Number	81212-D	81222-D	81232-D	81242-D
	Weight in Pounds	11.1	12.3	13.5	14.6
	Price				

The shaded items are too large to be Factory painted, they are furnished not cleaned of mill oil and not painted.

HEAVY GUARDIAN, Two Coat, Single Gate

Item # 81400-D

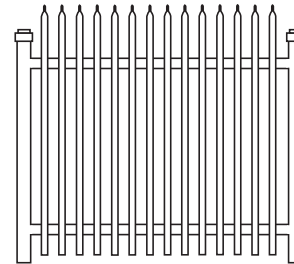
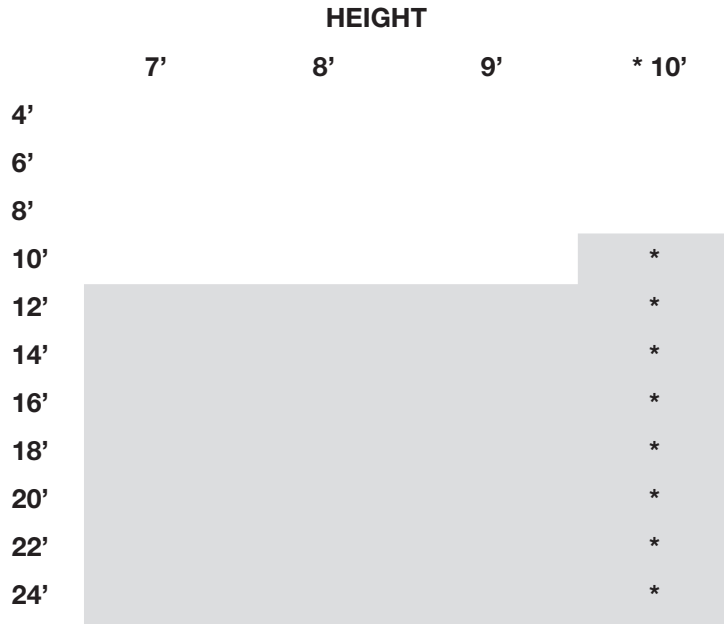

HEAVY GUARDIAN, Two Coat, Double Gate

Item # 81450-D

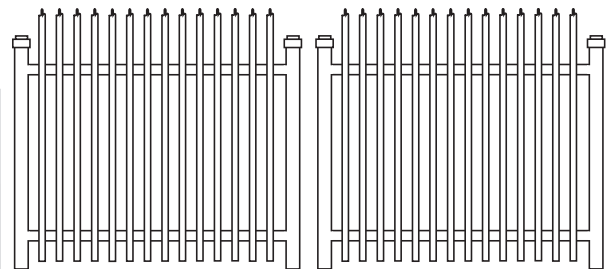
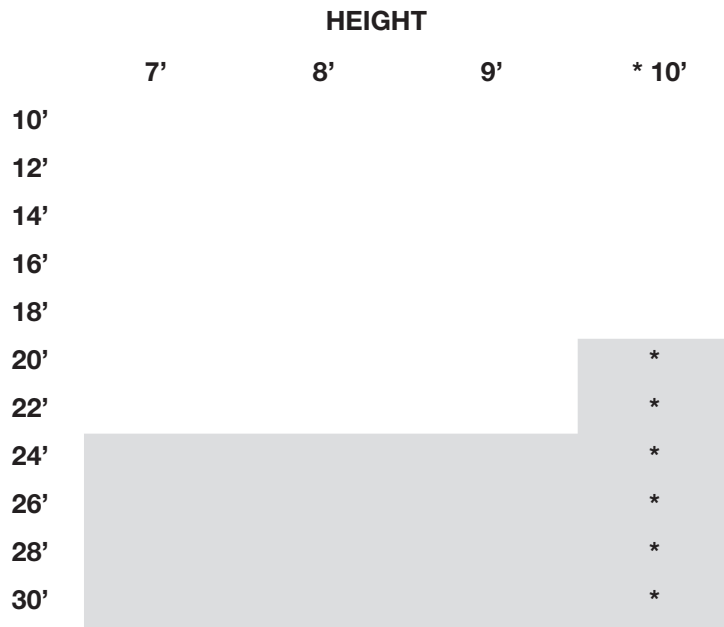

NOTES

Prices listed on this page are based on 4-inch picket spacing only and do not include hardware or trussing. Shaded areas on the pricing schedule indicate gates manufactured with a 2" frame required for additional strength.

FOR CUSTOM OPTIONS: arching, scroll work or a wide variety of design alternatives, see the **SPECIAL PRICING APPLICATIONS** section of this catalog.

* All 10' Guardian swing gates over 9' in width are too large to be factory painted. They are furnished not cleaned of mill oil and not painted.

CONVENTIONAL SLIDE GATE

GATE PRICES INCLUDE:

- 1 5/8" BFC 20 track
- 2 - P.S. pipe track wheels
- 2 - Clamp-on brackets
- 2 - P.S. caps
- 1 - 6" Rubber wheel
- Required track brackets
- Slide gate latch

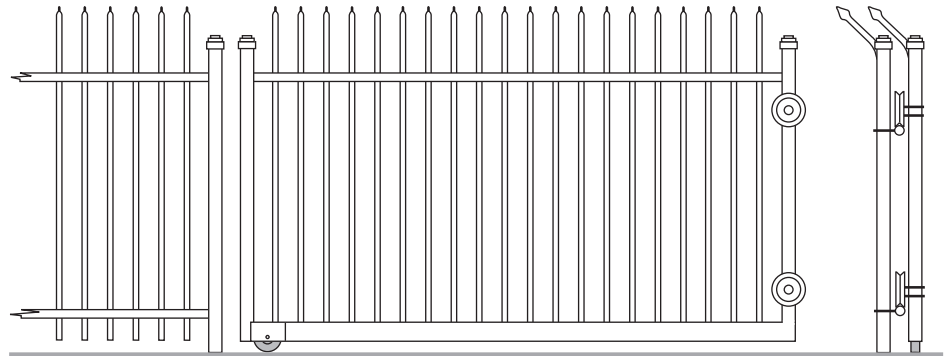

Item # 81474-D

2" x 4" BOTTOM RAIL

Gates are manufactured with 2" top rail and sides with a 2" x 4" bottom rail (4" view), 3/4" sq. pickets and 4" picket spacing. Old style gates with square bottom rail, old style wheel boxes, and pickets on the outside of the rail are available on request.

Call for pricing on custom variations.

End View Detail

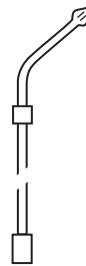

- Split Pickets
- Straighter gates because there is no welding on the outside of rails
- Wheel box part of bottom rail

Note: UL 325 requires electronically operated gates and the fence line adjoining such gates to have a maximum 2 1/8" picket spacing or mesh installed. For additional cost, contact sales person.

HEAVY GUARDIAN, Two Coat, Conventional Slide Gate

		HEIGHT		
O		7'	8'	9'
P				
E	10'			
N	12'			
I	14'			
N	16'			
G				

FOR CUSTOM OPTIONS: arching, scroll work or a wide variety of design alternatives, see the **SPECIAL PRICING APPLICATIONS** section of this catalog.

Please call for special pricing.

OVERHEAD ROLLER STYLE

GATE PRICES INCLUDE:

- 2 - P.S. caps
- 1 - Roller assembly
- 1 - Industrial slide latch
- 2 - 6" V-Groove wheels
- V-Track with J-bolts or Tabs

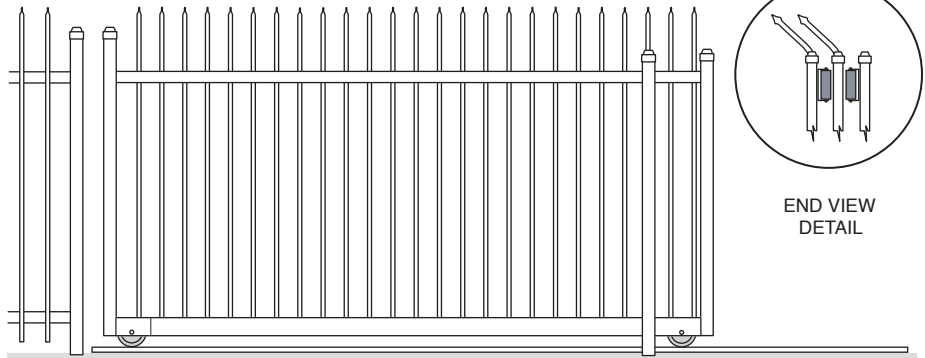

End View Detail

- Split Pickets
- Straighter gates because there is no welding on the outside of rails
- No strap needed across the pickets
- Wheel box part of bottom rail

Item # 81475-D

2" x 4" BOTTOM RAIL

Gates are manufactured with 2" top rail and sides with a 2" x 4" bottom rail (4" view), 3/4" sq. pickets and 4" picket spacing. Old style gates with square bottom rail, old style wheel boxes, and pickets on the outside of the rail are available on request. Call for pricing on custom variations. Shaded areas on the pricing schedule indicate gates manufactured with an 11 gauge frame required for additional strength. Trussing is optional and may be required for larger gates sizes. Refer to SPECIAL PRICING APPLICATION section.

Note: UL 325 requires electronically operated gates and the fence line adjoining such gates to have a maximum 2 1/8" picket spacing or mesh installed. For additional cost, contact sales person.

HEAVY GUARDIAN, Two Coat, Overhead Roller Assembly Style Slide Gate

		HEIGHT			
		7'	8'	9'	* 10'
	10'				*
O	12'				*
P	14'				*
E	16'				*
N	18'				*
I	20'				*
N	22'				*
G	24'				*
	26'				*
	28'				*
	30'				*

* All 10' Guardian slide gates over 9' in width are too large to be factory painted. They are furnished not cleaned of mill oil and not painted.

FOR CUSTOM OPTIONS: arching, scroll work or a wide variety of design alternatives, see the **SPECIAL PRICING APPLICATIONS** section of this catalog.

PICKET POSITION

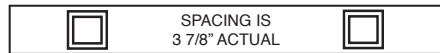

- 1" Square Top & Bottom Rail, 16 ga.
- 5/8" Square Pickets, 18 ga.
- 4" (3 7/8" actual) Spacing Between Pickets
- Power Washed for Paint Preparation
- One Shop Prime Coat
- One Top Coat Black Enamel

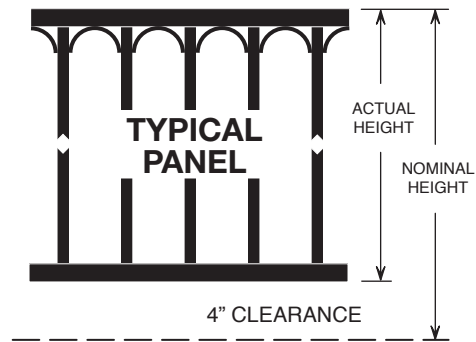

LIGHT EMPIRE, Two Coat, Conventional Sizes

For black polyurethane top coat add 10% to these prices
For pre-galvanized rail & pickets add 45% to these prices

Panels

	Nominal Height Actual Height	3' 32"	4' 44"	5' 56"	6' 68"
94" length	Item Number	75010-D	75110-D	75210-D	75310-D
	Weight in Pounds	38	46	54	62
	Price				
120" length	Item Number	75020-D	75120-D	75220-D	75320-D
	Weight in Pounds	49	59	69	79
	Price				
143 1/2" length	Item Number	75030-D	75130-D	75230-D	75330-D
	Weight in Pounds	58	70	82	90
	Price				

Single Gates

Includes standard hardware: an "A-Kit" and an "M-Kit"

	Nominal Height Actual Height	3' 32"	4' 44"	5' 56"	6' 68"
3' opening	Item Number	75409-D	75419-D	75429-D	75439-D
	Weight in Pounds	18	22	26	31
	Price				
4' opening	Item Number	75410-D	75420-D	75430-D	75440-D
	Weight in Pounds	21	26	31	36
	Price				

Double Gates

Includes standard hardware: 2 "A-Kits" and an "R5-Kit"

	Nominal Height Actual Height	3' 32"	4' 44"	5' 56"	6' 68"
10' opening	Item Number	75449-D	75459-D	75469-D	75479-D
	Weight in Pounds	56	68	81	94
	Price				
12' opening	Item Number	75450-D	75460-D	75470-D	75480-D
	Weight in Pounds	63	77	91	105
	Price				

BFC Ornamental Iron

LIGHT EMPIRE
Two Coat

LIGHT EMPIRE, Two Coat, Non-Conventional Sizes

PANELS • Item # 75000-D

To determine prices for non-standard sizes, use this list of "per foot" prices.

		HEIGHT						
		2'	3'	4'	5'	6'	7'	8'
per foot	-XX							

SINGLE GATES • Item # 75400-D

Single Gates include standard hardware: an "A-kit" and an "M-kit".

		HEIGHT						
		2'	3'	4'	5'	6'	7'	8'
WIDTH	3'							
	4'							
	5'							
	6'							
	7'							
	8'							
	9'							
	10'							

DOUBLE GATES • Item # 75455-D

Double Gates include standard hardware: 2 "A-kits" and an "R5-kit".

		HEIGHT						
		2'	3'	4'	5'	6'	7'	8'
WIDTH	6'							
	8'							
	10'							
	12'							
	14'							
	16'							
	18'							
	20'							

Prices are for rectangular fence and gates only.

For BIAS fence and gates, add \$ per lineal foot.

For TAPERED fence and gates, add \$ per lineal foot.

FOR CUSTOM OPTIONS: arching, scroll work or a wide variety of design alternatives, see the **SPECIAL PRICING APPLICATIONS** section of this catalog.

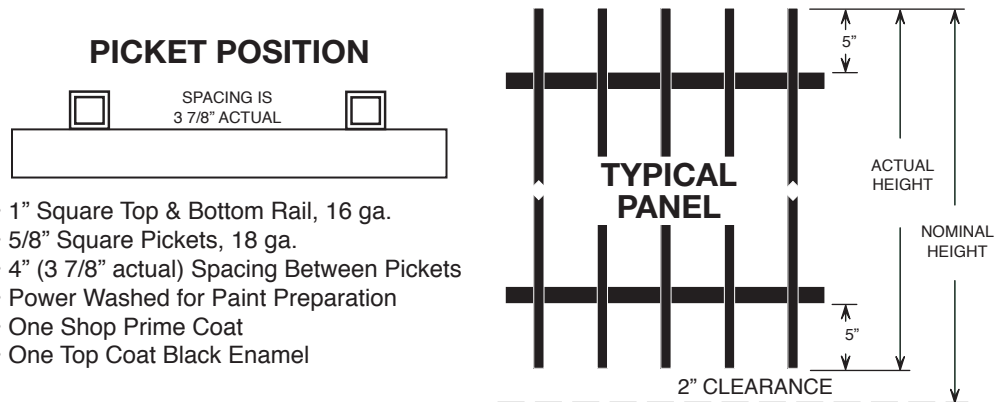

- 1" Square Top & Bottom Rail, 16 ga.
- 5/8" Square Pickets, 18 ga.
- 4" (3 7/8" actual) Spacing Between Pickets
- Power Washed for Paint Preparation
- One Shop Prime Coat
- One Top Coat Black Enamel

BFC recommends that plastic plug caps be installed at both ends of open pickets. Add cents per foot. Caps shipped loose. Request when ordering.

LIGHT MODERN, Two Coat, Conventional Sizes

For black polyurethane top coat add 10% to these prices

For pre-galvanized rail & pickets add 45% to these prices

Panels

	Nominal Height Actual Height	3' 34"	4' 46"	5' 58"	6' 70"
94" length	Item Number	76010-D	76110-D	76210-D	76310-D
	Weight in Pounds	36	44	52	60
	Price				
120" length	Item Number	76020-D	76120-D	76220-D	76320-D
	Weight in Pounds	46	56	66	76
	Price				
143 1/2" length	Item Number	76030-D	76130-D	76230-D	76330-D
	Weight in Pounds	54	66	78	90
	Price				

Single Gates

Includes standard hardware: an "A-Kit" and an "M-Kit"

	Nominal Height Actual Height	3' 34"	4' 46"	5' 58"	6' 70"
3' opening	Item Number	76409-D	76419-D	76429-D	76439-D
	Weight in Pounds	17	21	25	30
	Price				
4' opening	Item Number	76410-D	76420-D	76430-D	76440-D
	Weight in Pounds	20	25	30	35
	Price				

Double Gates

Includes standard hardware: 2 "A-Kits" and an "R5-Kit"

	Nominal Height Actual Height	3' 34"	4' 46"	5' 58"	6' 70"
10' opening	Item Number	76449-D	76459-D	76469-D	76479-D
	Weight in Pounds	53	66	79	92
	Price				
12' opening	Item Number	76450-D	76460-D	76470-D	76480-D
	Weight in Pounds	60	74	88	102
	Price				

BFC Ornamental Iron

LIGHT MODERN
Two Coat

LIGHT MODERN, Two Coat, Non-Conventional Sizes

PANELS • Item # 76000-D

To determine prices for non-standard sizes, use this list of "per foot" prices.

		HEIGHT						
		2'	3'	4'	5'	6'	7'	8'
per foot	-XX							

SINGLE GATES • Item # 76400-D

Single Gates include standard hardware: an "A-kit" and an "M-kit".

		HEIGHT						
		2'	3'	4'	5'	6'	7'	8'
WIDTH	3'							
	4'							
	5'							
	6'							
	7'							
	8'							
	9'							
	10'							

DOUBLE GATES • Item # 75455-D

Double Gates include standard hardware: 2 "A-kits" and an "R5-kit".

		HEIGHT						
		2'	3'	4'	5'	6'	7'	8'
WIDTH	6'							
	8'							
	10'							
	12'							
	14'							
	16'							
	18'							
	20'							

Prices are for rectangular fence and gates only.

For BIAS fence and gates, add \$ per lineal foot.

For TAPERED fence and gates, add \$ per lineal foot.

FOR CUSTOM OPTIONS: arching, scroll work or a wide variety of design alternatives, see the **SPECIAL PRICING APPLICATIONS** section of this catalog.

BFC Ornamental Iron

LIGHT NAPOLEON
Two Coat

PICKET POSITION

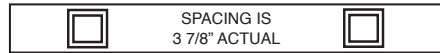

- 1" Square Top & Bottom Rail, 16 ga.
- 5/8" Square Pickets, 18 ga.
- 4" (3 7/8" actual) Spacing Between Pickets
- Power Washed for Paint Preparation
- One Shop Prime Coat
- One Top Coat Black Enamel

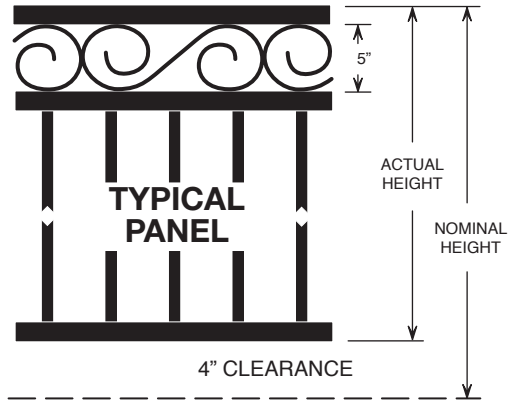

LIGHT NAPOLEON, Two Coat, Conventional Sizes

For black polyurethane top coat add 10% to these prices

For pre-galvanized rail & pickets add 45% to these prices

Panels

	Nominal Height Actual Height	3' 32"	4' 44"	5' 56"	6' 68"
94" length	Item Number	73010-D	73110-D	73210-D	73310-D
	Weight in Pounds	40	48	56	64
120" length	Item Number	73020-D	73120-D	73220-D	73320-D
	Weight in Pounds	52	62	72	82
143 1/2" length	Item Number	73030-D	73130-D	73230-D	73330-D
	Weight in Pounds	63	75	87	99

Single Gates

Includes standard hardware: an "A-Kit" and an "M-Kit"

	Nominal Height Actual Height	3' 32"	4' 44"	5' 56"	6' 68"
3' opening	Item Number	73409-D	73419-D	73429-D	73439-D
	Weight in Pounds	21	25	29	33
4' opening	Item Number	73410-D	73420-D	73430-D	73440-D
	Weight in Pounds	26	31	36	41

Double Gates

Includes standard hardware: 2 "A-Kits" and an "R5-Kit"

	Nominal Height Actual Height	3' 32"	4' 44"	5' 56"	6' 68"
10' opening	Item Number	73449-D	73459-D	73469-D	73479-D
	Weight in Pounds	60	72	84	96
12' opening	Item Number	73450-D	73460-D	73470-D	73480-D
	Weight in Pounds	72	86	100	114

BFC Ornamental Iron

LIGHT NAPOLEON
Two Coat

LIGHT NAPOLEON, Two Coat, Non-Conventional Sizes

PANELS • Item # 73000-D

To determine prices for non-standard sizes, use this list of "per foot" prices.

		HEIGHT						
		2'	3'	4'	5'	6'	7'	8'
per foot	-XX							

SINGLE GATES • Item # 73400-D

Single Gates include standard hardware: an "A-kit" and an "M-kit".

		HEIGHT						
		2'	3'	4'	5'	6'	7'	8'
WIDTH	3'							
	4'							
	5'							
	6'							
	7'							
	8'							
	9'							
	10'							

DOUBLE GATES • Item # 73455-D

Double Gates include standard hardware: 2 "A-kits" and an "R5-kit".

		HEIGHT						
		2'	3'	4'	5'	6'	7'	8'
WIDTH	6'							
	8'							
	10'							
	12'							
	14'							
	16'							
	18'							
	20'							

Prices are for rectangular fence and gates only.

For BIAS fence and gates, add \$ per lineal foot.

For TAPERED fence and gates, add \$ per lineal foot.

FOR CUSTOM OPTIONS: arching, scroll work or a wide variety of design alternatives, see the **SPECIAL PRICING APPLICATIONS** section of this catalog.

BFC Ornamental Iron

LIGHT REGAL
One Coat

PICKET POSITION

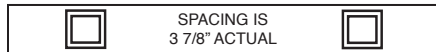

- 1" Square Top & Bottom Rail, 16 ga.
- 5/8" Square Pickets, 18 ga.
- 4" (3 7/8" actual) Spacing between Pickets
- Power Washed for Paint Preparation
- One Prime Coat Black

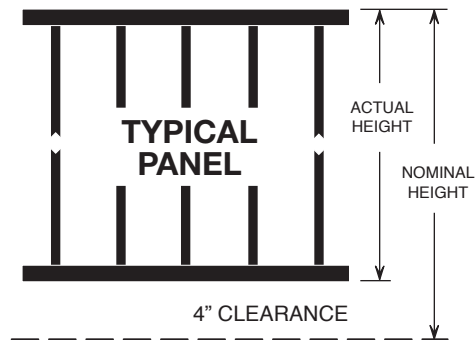

LIGHT REGAL, One Coat, Conventional Sizes

Panels

	Nominal Height Actual Height	3' 32"	3 1/2' 38"	4' 44"	5' 56"	SPECIAL 58"	6' 68"
94" length	Item Number	68010-S	68040-S	68110-S	68210-S	68240-S	68310-S
	Weight in Pounds	33	37	41	49	51	57
120" length	Item Number	68020-S	68050-S	68120-S	68220-S	68250-S	68320-S
	Weight in Pounds	42	47	52	62	64	72
143 1/2" length	Item Number	68030-S	68060-S	68130-S	68230-S	68260-S	68330-S
	Weight in Pounds	50	56	62	74	77	86

Single Gates

Includes standard hardware: an "A-Kit" and an "M-Kit"

	Nominal Height Actual Height	3' 32"	3 1/2' 38"	4' 44"	5' 56"	SPECIAL 58"	6' 68"
3' opening	Item Number	68409-S	68414-S	68419-S	68429-S	68435-S	68439-S
	Weight in Pounds	16	18	20	24	25	29
4' opening	Item Number	68410-S	68415-S	68420-S	68430-S	68436-S	68440-S
	Weight in Pounds	19	22	24	29	31	34

Double Gates

Includes standard hardware: 2 "A-Kits" and an "R5-Kit"

	Nominal Height Actual Height	3' 32"	3 1/2' 38"	4' 44"	5' 56"	SPECIAL 58"	6' 68"
10' opening	Item Number	68449-S	68454-S	68459-S	68469-S	68485-S	68479-SS
	Weight in Pounds	49	55	62	75	78	88
12' opening	Item Number	68450-S	68455-S	68460-S	68470-S	68487-S	68480-S
	Weight in Pounds	56	63	70	84	87	98

BFC Ornamental Iron

LIGHT REGAL
One Coat

LIGHT REGAL, One Coat, Non-Conventional Sizes

PANELS • Item # 68000-S

To determine prices for non-standard sizes, use this list of "per foot" prices.

		HEIGHT					
		2'	3'	3 1/2'	4'	5'	6'
per foot	-XX						

SINGLE GATES • Item # 68400-S

Single Gates include standard hardware: an "A-kit" and an "M-kit".

		HEIGHT					
		2'	3'	3 1/2'	4'	5'	6'
WIDTH	3'						
	4'						
	5'						
	6'						
	7'						
	8'						
	9'						
	10'						

DOUBLE GATES • Item # 68450-S

Double Gates include standard hardware: 2 "A-kits" and an "R5-kit".

		HEIGHT					
		2'	3'	3 1/2'	4'	5'	6'
WIDTH	6'						
	8'						
	10'						
	12'						
	14'						
	16'						
	18'						
	20'						

Prices are for rectangular fence and gates only.
 For BIAS fence and gates, add \$ per lineal foot.
 For TAPERED fence and gates, add \$ per lineal foot.
 Biasable fence panels in standard sizes are available, see biasable price page 48.

FOR CUSTOM OPTIONS: arching, scroll work or a wide variety of design alternatives, see the **SPECIAL PRICING APPLICATIONS** section of this catalog.

BFC Ornamental Iron LIGHT ARISTOCRAT One Coat

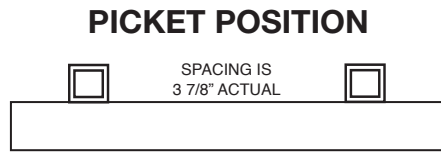

- 1" Square Top & Bottom Rail, 16 ga.
- 5/8" Square Pickets, 18 ga.
- 4" (3 7/8" actual) Spacing Between Pickets
- Power Washed for Paint Preparation
- One Prime Coat Black

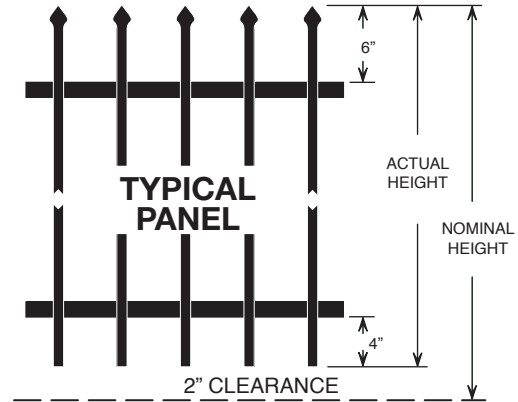

LIGHT ARISTOCRAT, One Coat, Conventional Sizes

Panels

	Nominal Height Actual Height	3' 34"	4' 46"	5' 58"	6' 70"
94" length	Item Number	69010-S	69110-S	69210-S	69310-S
	Weight in Pounds	36	44	52	60
120" length	Item Number	69020-S	69120-S	69220-S	69320-S
	Weight in Pounds	46	56	66	76
143 1/2" length	Item Number	69030-S	69130-S	69230-S	69330-S
	Weight in Pounds	54	66	78	90
	Price				

Single Gates

Includes standard hardware: an "A-Kit" and an "M-Kit"

	Nominal Height Actual Height	3' 34"	4' 46"	5' 58"	6' 70"
3' opening	Item Number	69409-S	69419-S	69429-S	69439-S
	Weight in Pounds	17	21	25	30
4' opening	Item Number	69410-S	69420-S	69430-S	69440-S
	Weight in Pounds	20	25	30	35
	Price				

Double Gates

Includes standard hardware: 2 "A-Kits" and an "R5-Kit"

	Nominal Height Actual Height	3' 34"	4' 46"	5' 58"	6' 70"
10' opening	Item Number	69459-S	69469-S	69479-S	69489-S
	Weight in Pounds	53	66	79	92
12' opening	Item Number	69460-S	69470-S	69480-S	69490-S
	Weight in Pounds	60	74	88	102
	Price				

BFC Ornamental Iron LIGHT ARISTOCRAT One Coat

LIGHT ARISTOCRAT, One Coat, Non-Conventional Sizes

PANELS • Item # 69000-S

To determine prices for non-standard sizes, use this list of "per foot" prices.

		HEIGHT				
		2'	3'	4'	5'	6'
per foot	-XX					

SINGLE GATES • Item # 69400-S

Single Gates include standard hardware: an "A-kit" and an "M-kit".

		HEIGHT				
		2'	3'	4'	5'	6'
WIDTH	3'					
	4'					
	5'					
	6'					
	7'					
	8'					
	9'					
	10'					

DOUBLE GATES • Item # 69450-S

Double Gates include standard hardware: 2 "A-kits" and an "R5-kit".

		HEIGHT				
		2'	3'	4'	5'	6'
WIDTH	6'					
	8'					
	10'					
	12'					
	14'					
	16'					
	18'					
	20'					

Prices are for rectangular fence and gates only.
 For BIAS fence and gates, add \$ per lineal foot.
 For TAPERED fence and gates, add \$ per lineal foot.

FOR CUSTOM OPTIONS: arching, scroll work or a wide variety of design alternatives, see the **SPECIAL PRICING APPLICATIONS** section of this catalog.

PICKET POSITION

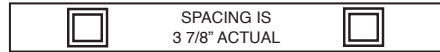

- 1" Square Top & Bottom Rail, 16 ga.
- 5/8" Square Pickets, 18 ga.
- 4" (3 7/8" actual) Spacing Between Pickets
- Power Washed for Paint Preparation
- One Prime Coat Black

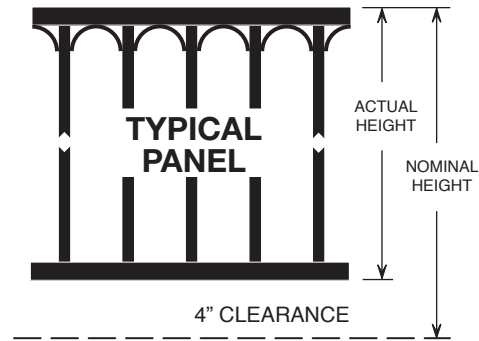

LIGHT EMPIRE, One Coat, Conventional Sizes

Panels

	Nominal Height Actual Height	3' 32"	4' 44"	5' 56"	6' 68"
94" length	Item Number	75010-S	75110-S	75210-S	75310-S
	Weight in Pounds	38	46	54	62
	Price	57.89	66.84	75.82	84.77
120" length	Item Number	75020-S	75120-S	75220-S	75320-S
	Weight in Pounds	49	59	69	79
	Price	75.95	87.74	99.49	111.30
143 1/2" length	Item Number	75030-S	75130-S	75230-S	75330-S
	Weight in Pounds	58	70	82	90
	Price	91.15	103.94	119.42	133.57

Single Gates

Includes standard hardware: an "A-Kit" and an "M-Kit"

	Nominal Height Actual Height	3' 32"	4' 44"	5' 56"	6' 68"
3' opening	Item Number	75409-S	75419-S	75429-S	75439-S
	Weight in Pounds	18	22	26	31
	Price	72.05	77.78	83.57	89.23
4' opening	Item Number	75410-S	75420-S	75430-S	75440-S
	Weight in Pounds	21	26	31	36
	Price	80.62	87.77	94.94	97.10

Double Gates

Includes standard hardware: 2 "A-Kits" and an "R5-Kit"

	Nominal Height Actual Height	3' 32"	4' 44"	5' 56"	6' 68"
10' opening	Item Number	75449-S	75459-S	75469-S	75479-S
	Weight in Pounds	56	68	81	94
	Price	189.56	206.57	223.58	240.59
12' opening	Item Number	75450-S	75460-S	75470-S	75480-S
	Weight in Pounds	63	77	91	105
	Price	206.84	226.60	246.36	266.10

BFC Ornamental Iron

LIGHT EMPIRE
One Coat

LIGHT EMPIRE, One Coat, Non-Conventional Sizes

PANELS • Item # 75000-S

To determine prices for non-standard sizes, use this list of "per foot" prices.

		HEIGHT				
		2'	3'	4'	5'	6'
per foot	-XX					

SINGLE GATES • Item # 75400-S

Single Gates include standard hardware: an "A-kit" and an "M-kit".

		HEIGHT				
		2'	3'	4'	5'	6'
WIDTH	3'					
	4'					
	5'					
	6'					
	7'					
	8'					
	9'					
	10'					

DOUBLE GATES • Item # 75455-S

Double Gates include standard hardware: 2 "A-kits" and an "R5-kit".

		HEIGHT				
		2'	3'	4'	5'	6'
WIDTH	6'					
	8'					
	10'					
	12'					
	14'					
	16'					
	18'					
	20'					

Prices are for rectangular fence and gates only.
For BIAS fence and gates, add \$ per lineal foot.
For TAPERED fence and gates, add \$ per lineal foot.

FOR CUSTOM OPTIONS: arching, scroll work or a wide variety of design alternatives, see the **SPECIAL PRICING APPLICATIONS** section of this catalog.

BFC Ornamental Iron

LIGHT MODERN
One Coat

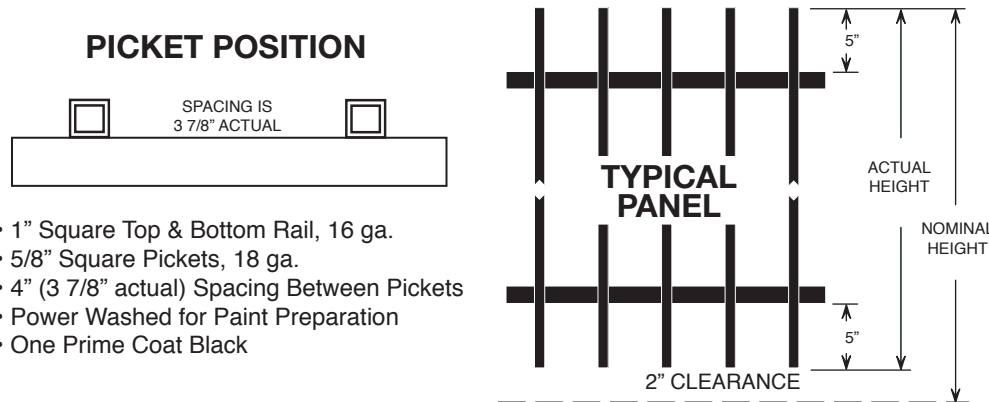

- 1" Square Top & Bottom Rail, 16 ga.
- 5/8" Square Pickets, 18 ga.
- 4" (3 7/8" actual) Spacing Between Pickets
- Power Washed for Paint Preparation
- One Prime Coat Black

LIGHT MODERN, One Coat, Conventional Sizes

Panels

	Nominal Height Actual Height	3' 34"	4' 46"	5' 58"	6' 70"
94" length	Item Number	76010-S	76110-S	76210-S	76310-S
	Weight in Pounds	36	44	52	60
120" length	Item Number	76020-S	76120-S	76220-S	76320-S
	Weight in Pounds	46	56	66	76
143 1/2" length	Item Number	76030-S	76130-S	76230-S	76330-S
	Weight in Pounds	54	66	78	90

Single Gates

Includes standard hardware: an "A-Kit" and an "M-Kit"

	Nominal Height Actual Height	3' 34"	4' 46"	5' 58"	6' 70"
3' opening	Item Number	76409-S	76419-S	76429-S	76439-S
	Weight in Pounds	17	21	25	30
4' opening	Item Number	76410-S	76420-S	76430-S	76440-S
	Weight in Pounds	20	25	30	35

Double Gates

Includes standard hardware: 2 "A-Kits" and an "R5-Kit"

	Nominal Height Actual Height	3' 34"	4' 46"	5' 58"	6' 70"
10' opening	Item Number	76449-S	76459-S	76469-S	76479-S
	Weight in Pounds	53	66	79	92
12' opening	Item Number	76450-S	76460-S	76470-S	76480-S
	Weight in Pounds	60	74	88	102

BFC Ornamental Iron

LIGHT MODERN
One Coat

LIGHT MODERN, One Coat, Non-Conventional Sizes

PANELS • Item # 76000-S

To determine prices for non-standard sizes, use this list of "per foot" prices.

		HEIGHT				
		2'	3'	4'	5'	6'
per foot	-XX					

SINGLE GATES • Item # 76400-S

Single Gates include standard hardware: an "A-kit" and an "M-kit".

		HEIGHT				
		2'	3'	4'	5'	6'
WIDTH	3'					
	4'					
	5'					
	6'					
	7'					
	8'					
	9'					
	10'					

DOUBLE GATES • Item # 76455-S

Double Gates include standard hardware: 2 "A-kits" and an "R5-kit".

		HEIGHT				
		2'	3'	4'	5'	6'
WIDTH	6'					
	8'					
	10'					
	12'					
	14'					
	16'					
	18'					
	20'					

Prices are for rectangular fence and gates only.
For BIAS fence and gates, add \$ per lineal foot.
For TAPERED fence and gates, add \$ per lineal foot.

FOR CUSTOM OPTIONS: arching, scroll work or a wide variety of design alternatives, see the **SPECIAL PRICING APPLICATIONS** section of this catalog.

BFC Ornamental Iron LIGHT REGAL PANELS Biasable, One Coat

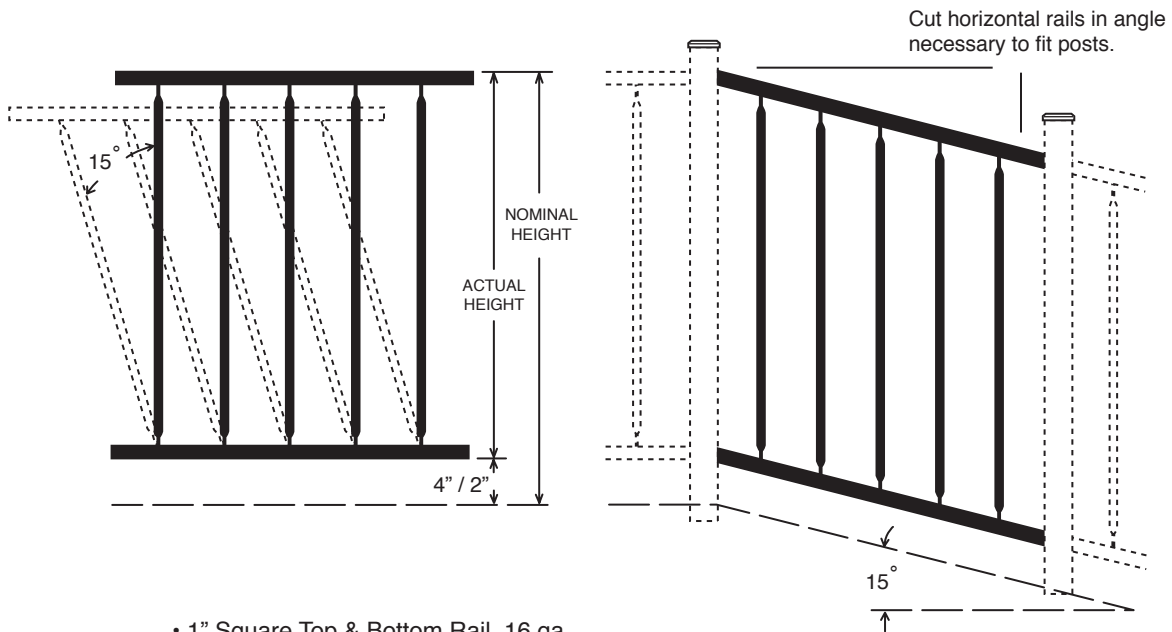

- 1" Square Top & Bottom Rail, 16 ga.
- 5/8" Square Pickets, 18 ga.
- 4" (3 7/8" actual) Spacing Between Pickets
- Power Washed for Paint Preparation
- One Prime Coat Black

LIGHT REGAL PANELS, Biasable, One Coat

Nominal Height Actual Height	HEIGHT					
	3' 32"	3 1/2' 38"	4' 44"	5' 56"	SPECIAL 58"	6' 68"
Net LENGTH						
Item Number 94"	77010-S	77041-S	77110-S	77210-S	77240-S	77310-S
Item Number 120"	77020-S	77042-S	77120-S	77220-S	77250-S	77320-S
Item Number 143 1/2"	77030-S	77043-S	77130-S	77230-S	77260-S	77330-S

TRASH ENCLOSURE DOUBLE GATES

Height

5 ft & 6 ft

Opening

up to 9 ft & up to 12 ft

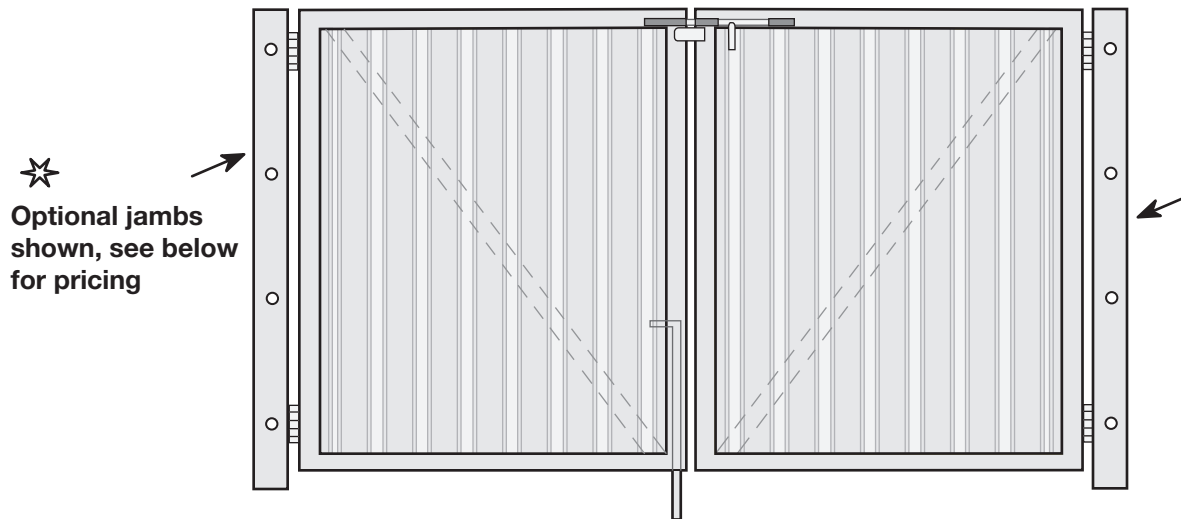

✱
Optional jambs
shown, see below
for pricing

Gates are manufactured with 1/4" x 2" x 2" angle frames, 1/4" x 2" flat bar diagonal bracing, 20 GA galvanized decking, factory installed 4 x 4 butt hinges, heavy drop rod and slide bolt. Gates are shipped with one coat high solids primer only.

Item #	Height	Opening	Price
81350-108	5'	9' or less	
81350-144	5'	12' or less	
81360-108	6'	9' or less	
81360-144	6'	12' or less	

For optional top coat of polyurethane (furnish color sample) add \$ _____ per set.
(Touch-up paint included.)

✱ For optional 3" channel jamb or 4" angle jamb, welded to the gate hinges, with (4) mounting holes furnished add \$ _____ per set.

BOTTOM TRACK CANTILEVER GATE SYSTEM

Heavy Regal

For pricing system components only see page 7 in Rolling Gate Hardware.

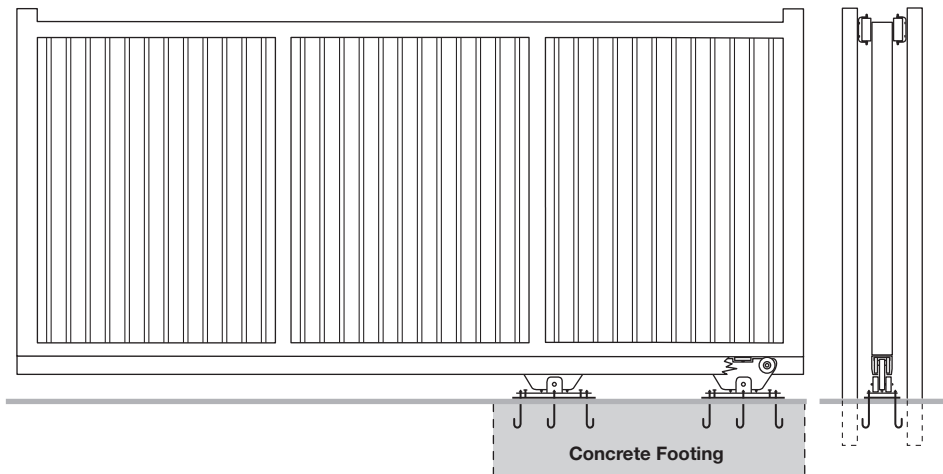

Each Gate Requires

- 1 or more Cantilever Bottom Track *
- 2 ea. Cantilever Gate Trolley
- 2 ea. (Optional) Trolley Ground Plate
- 12 ea. Hook Bolts
- 2 ea. Receiver Cup
- 2 ea. End Wheel Cap
- 2 ea. BFC Type II (O.H. roller set)

* 236" long track sold in FULL LENGTHS ONLY.
33 foot maximum opening,
2,200 lb. maximum total weight,
All items are galvanized.

Heavy Aristocrat

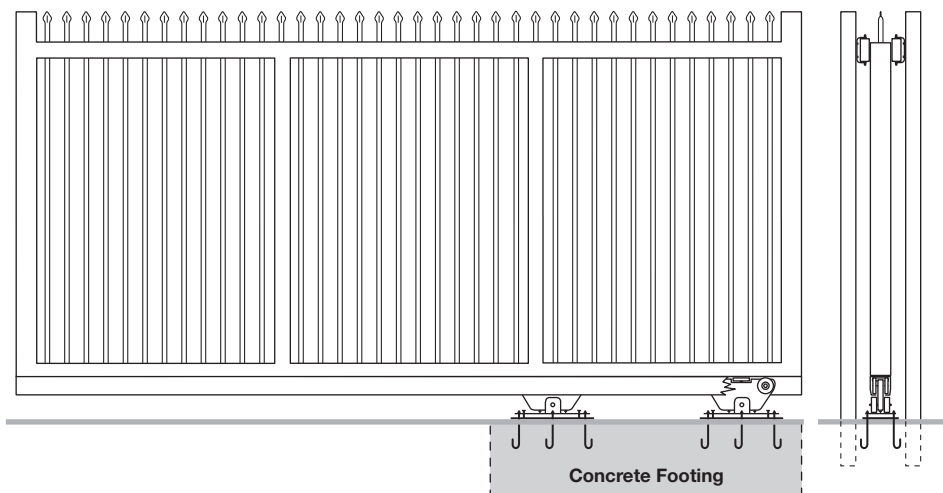

Heavy Guardian

For heavier gates, call for quotation.

