

### TOOLS SECTION

<b>UTICA-STYLE PLIERS - ROUND</b> <b>CRESCENT PLIERS - SQUARE</b> <b>HEAVY DUTY FENCE PLIERS</b> <b>END CUTTER - NIPS</b> <b>HOG RING PLIERS</b> ..... Page 2	<b>PIPE CUTTERS</b> <b>PIPE CUTTER BLADES</b> <b>RECIPROCATING BLADES</b> .....Page 8
<b>BOLT CUTTERS</b> <b>STRETCHING BARS</b> <b>PANEL STRETCHER</b> <b>FENCE STRETCHER</b> <b>TAPE MEASURE</b> <b>TORPEDO LEVEL</b> ..... Page 3	<b>PIPE NOTCHERS</b> <b>PRESS &amp; STANDARD HOUSING</b> <b>PUNCH &amp; DIE ASSEMBLIES</b> .....Page 9
<b>DIGGER BARS</b> <b>POST HOLE DIGGERS</b> <b>REPLACEMENT HANDLES</b> <b>POST DRIVERS</b> <b>LEATHER GLOVES</b> ..... Page 4	<b>EARTH DRILLS &amp; ACCESSORIES</b> <b>GROUND HOG EARTH DRILLS</b> <b>AUGERS</b> <b>EXTENSIONS / BLADES</b> ..... Pages 10-11
<b>WIRE STRETCHERS</b> <b>WIRE GRIPS &amp; ACCESSORIES</b> <b>PUL-JAK</b> <b>BARBED WIRE CARRIER</b> ..... Page 5	<b>LITTLE BEAVER EARTH DRILLS</b> <b>MECHANICAL EARTH DRILLS &amp;</b> <b>HYDRAULIC EARTH DRILLS</b> <b>BLADES / AUGERS</b> ..... Pages 12, 13, 14
<b>PFERD ABRASIVE PRODUCTS</b> ..... Page 6-7	

8530 UNSWORTH AVE. SACRAMENTO, CA 95828-1009 1-916-381-4065	13111 DAHLIA ST. FONTANA, CA 92337-6902 1-909-350-9040	8937 SAN FERNANDO RD. SUN VALLEY, CA 91352-1410 1-818-504-3700	1265 N. CUYAMACA ST. EL CAJON, CA 92020-1549 1-619-449-0333	10010 PORTLAND AVE. TACOMA, WA 98445-3956 1-253-535-5500
---	--	--	---	--

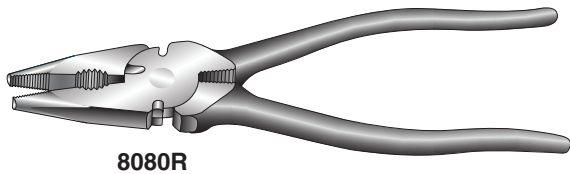

8080R

### UTICA-STYLE FENCE PLIERS

Size	Item#	PRICE	
		1 to 9	10 +
<b>Round Nose</b>			
10" Round Nose	63109-10		

- Extended nose allows greater reach
- High quality
- Smooth working action

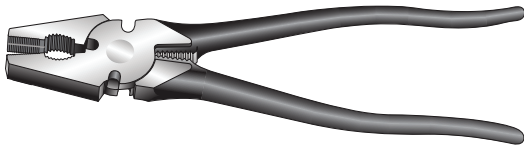

### CRESCENT PLIERS - SQUARE

8"	61329
10"	61330

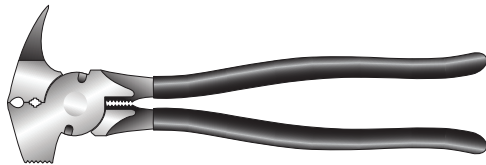

### HEAVY DUTY FENCE PLIERS

10"	61331
-----	-------

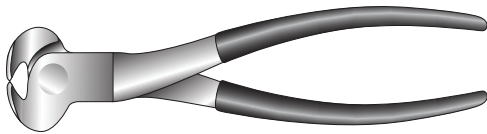

### END CUTTER - NIPPERS

<b>Blue Handle #357 Channellock</b>	
7"	61349

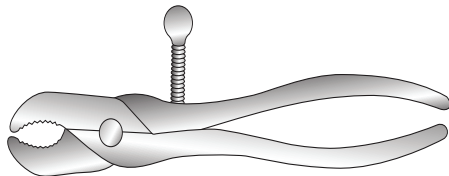

### HOG RING PLIERS

H. M. (Small)	61334
H. L. M. (Large)	61335
B.O.E.	61336
RR-HS w/spring	61337

### BOLT CUTTERS

Size	Item#	PRICE	
		1 to 9	10 +
14"	61370		
18"	61371		
24"	61317		

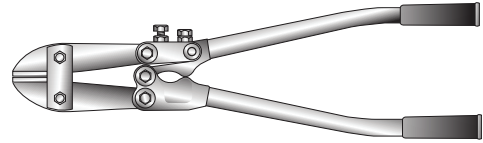

### STRETCHING BARS

3' (for 3' fence)	61392
4' (for 4' fence)	61393
5' (for 5' & 6' fence)	61394
6' (for over 6' fence)	61395

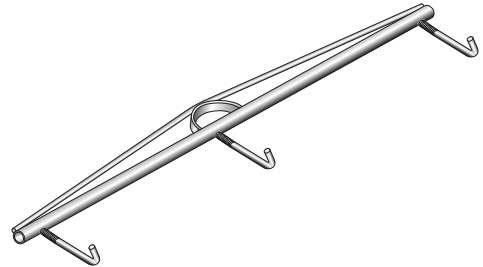

### PANEL STRETCHER

61396

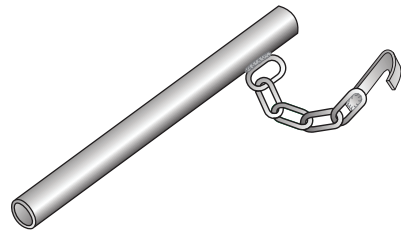

### FENCE STRETCHER

For 1 3/8" to 4" post

61396-10

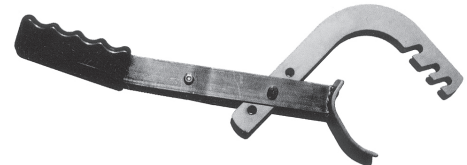

### TAPE MEASURE, 1"

Description	Item#	1 to 11	12 to 17	18 +
30' x 1"	61436-10			

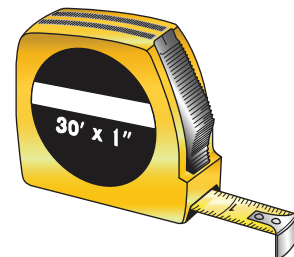

### TORPEDO LEVEL — ALUMINUM BODY

Description	Item#	1 to 5	6 to 11	12 +
Magnetic 9"	63104			

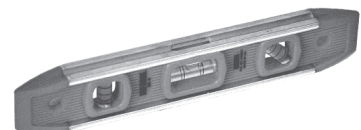

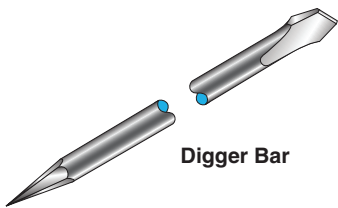

Digger Bar

### DIGGER BAR

Description	Item#	1 to 5	6 to 11	12 +
1 1/4" x 72" round	62169			

### SEYMOUR POST HOLE DIGGERS

#### Wood handle Diggers

DG-10	Heavy Atlas (blue)	61297
DG-11	Hercules (blue)	61382
DG-12	Perfection (blue)	61385-10
DG-100	Atlas (red)	61383

#### Fiberglass Handle Diggers

DG-11FG	Hercules (blue)	61382-10
DG-12FG	Perfection (blue)	61385-20
DG-100FG	Atlas (red)	61383-10

#### Replacement Handles

(Price is per handle: Not per pair)

DG-10H	DG-10H Wood	61385
FG-11	Fiberglass (yellow) (fits DG-100FG)	61372
FG-48	Fiberglass (red) (fits DG-11FG & DG-12FG)	61372-10

### Special Features

#### DG-11, Blue

Heavy Duty Digger. Super tough, high carbon steel blades riveted to high tensile strength steel yoke. Blades are 6 1/4" apart at tips.

#### DG-100, Red

Carbon steel blades riveted to high-strength steel yoke. Blades are 5 1/2" apart at tips.

#### Handles (Wood or Fiberglass)

For DG-10, DG-11, DG-12, DG-100 post hole diggers. Price is per handle. **Not a pair.**

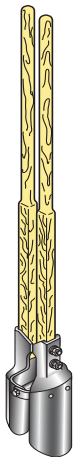

DG-11

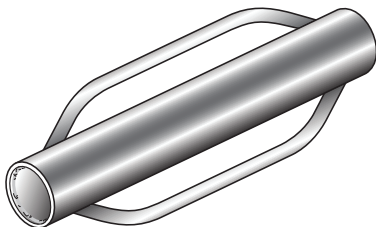

### POST DRIVERS

Description	Item#	1 to 5	6 to 11	12 +
16 lb without handle	61389			
26 lb without handle	61390			
26 lb with handles	61391			

### LEATHER GLOVES

Description	Item#	1 to 11	12 to 23	24 +
Work Gloves	61375			



### WIRE STRETCHERS & ACCESSORIES

Description	Item#	1 to 5	6 to 11	12 +
-------------	-------	--------	---------	------

#### **MAASDAM**

(2,000 lb. capacity)

Cable Pow'R-Pull 144S-6                      61386  
 Strap Pull'R WS-1                              61386-WS

Replacement parts available. Ask your sales person.

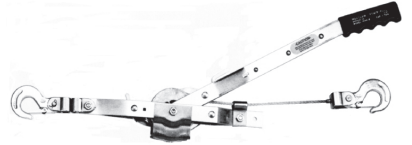

#### Parts / Accessories

Extra Cable    12' w/clevis for 144S-6    61387  
 Extra Strap    12' strap for WS-1                      61387-WS  
 Wire Grip                                      61388

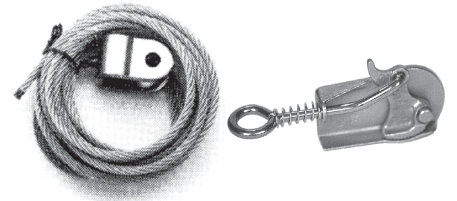

### **WIRE GRIPS**

Klein Haven                                      61388-10



### **PULJAK**

A-2.5                      wire/panel stretcher                      61397  
 PulJak                      P-122 repair kit \*                      61397-10  
 \* Comes with 1 trigger cam, 1 small cam, 2 springs



### **BARBED WIRE CARRIER**

BFC Carrier                                      61288

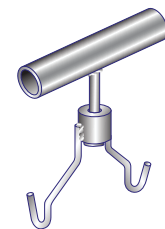

8530 UNSWORTH AVE. SACRAMENTO, CA 95828-1009 1-916-381-4065	13111 DAHLIA ST. FONTANA, CA 92337-6902 1-909-350-9040	8937 SAN FERNANDO RD. SUN VALLEY, CA 91352-1410 1-818-504-3700	1265 N. CUYAMACA ST. EL CAJON, CA 92020-1549 1-619-449-0333	10010 PORTLAND AVE. TACOMA, WA 98445-3956 1-253-535-5500
---	--	--	---	--

Item#	Description	Box Qty.	Less Box Qty.	Box Qty.
-------	-------------	----------	---------------	----------

### SANDING DISCS

**PF62533 5" Quick Change Alum. Oxide** 25  
 Aluminum Oxide A sanding disc with quick-change hub, 5" diameter, 5/8-11 thread, 36 grit, 12,200 max. RPM. For general-purpose grinding.



**PF62543 5" Quick Change Alum. Zirconia** 25  
 Zirconia Alumina Z sanding disc with quick-change hub. 5" diameter, 5/8-11 thread, 36 grit, 12,200 max. RPM. Designed for coarse grinding and high stock removal, with an extended service life. Zirconia alumina is a high-performance abrasive which delivers best results on high-powered angle grinders at increased contact pressure.



**PF69525 5" Ribbed Backing Pads** 25  
 Ribbed rubber backing pad for sanding discs. 5" diameter, 5/8-11 thread size, regular backing density, 10,000 max. RPM. Ribbed design allows for better cooling, which improves disc life.



### GRINDING WHEELS



**PF61001 4 1/2" x 1/4"; 5/8"-11, 24 Grit, Type 27** 10  
 Aluminum Oxide grinding wheel for steel and cast iron. 4-1/2" diameter, 1/4" thickness, 5/8-11 thread, 24 grit, 13,300 max. RPM. General purpose grinding wheel for use on all metals. Smooth grinding action and fast removal rates with minimal contact pressure. Manufactured without addition of ferrous, sulphurous or chlorinated fillers. For surface grinding and edge grinding. Use with angle grinders of all power output levels.

**PF61008 5" x 1/4"; 5/8"-11, 24 Grit, Type 27** 10  
 Aluminum Oxide grinding wheel for steel and cast iron. 5" diameter, 1/4" thickness, 5/8-11 thread, 24 grit, 12,200 max. RPM.

**PF61006 7" x 1/4"; 5/8"-11, 24 Grit, Type 27** 10  
 Aluminum Oxide grinding wheel for steel and cast iron. 7" diameter, 1/4" thickness, 5/8-11 thread, 24 grit, 8,600 max. RPM.

8530 UNSWORTH AVE. SACRAMENTO, CA 95828-1009 1-916-381-4065	13111 DAHLIA ST. FONTANA, CA 92337-6902 1-909-350-9040	8937 SAN FERNANDO RD. SUN VALLEY, CA 91352-1410 1-818-504-3700	1265 N. CUYAMACA ST. EL CAJON, CA 92020-1549 1-619-449-0333	10010 PORTLAND AVE. TACOMA, WA 98445-3956 1-253-535-5500
---	--	--	---	--

Item#	Description	Box Qty.	Less Box Qty.	Box Qty.
-------	-------------	----------	---------------	----------

### CUT-OFF WHEELS

PF63115      **4 1/2" x 1/8", 5/8-11, Type 27**

10

Aluminum Oxide cut-off wheel for steel and cast iron, Type 27 (depressed center). 4-1/2" diameter, 1/8" thickness, 5/8-11 thread, 46 grit, 13,300 max. RPM. Use for cutting of sheet metal, sections, and solid material. 1/8" thickness for maximum tool life with high lateral stability. Use with angle grinders of all power output levels.



PF63842      **7" x 1/8", 5/8" AH, Type I**

25

Aluminum Oxide cut-off wheel for steel, Type 1 (flat). 7" diameter, 1/8" thickness, diamond 5/8-1/2 arbor hole, 24 grit, 8,600 max. RPM. Performance cut-off wheels with diamond-shaped bore for use with circular saws. Includes 5/8" and 1/2" adapters for use on angle grinders and straight shaft grinders. For cutting of sheet metal, sections, and solid material.



PF64502      **14" x 3/32" Chop Saw Wheel, 1" AH**

10

Aluminum Oxide cut-off wheel for steel. 14" diameter, 3/32" thickness, 1" arbor hole, 36 grit, 4,400 max. RPM. Multipurpose tool for abrasive cutting operations using stationary machines. Aggressive abrasive performance for fast cuts and very long tool life. For cutting of sections and solid material, rebar, tubing, and other small cross sections. Use with up to 5 horsepower output machines.



### SPECIALTY

PF63340      **5" x 1/8" Duo Disc, 5/8-11, 46 Grit**

10

GRINDING AND CUTTING WITH THE SAME DISC  
DUODISC® combination cutting & grinding disc. 5" diameter, 1/8" thickness, 5/8-11 thread, 12,200 max. RPM. DUODISC® combination cutting, light deburring and surface grinding wheels conform to U.S. and international safety standards. 1/8" thickness for maximum tool life and high lateral stability. Manufactured without addition of ferrous, sulphurous or chlorinated fillers. Long service life and fast cutting action with angle grinders of all power outputs.



### HAND TOOLS

PF85033      **Wire Brush, Shoe Handle**

12

Shoe handle wire brush without scraper. 4 x 16 wire rows, 5" brush part length, carbon steel wire filament, 10-1/4" x 1-1/8" block, 1-3/16" trim length. PFERD Advance Brush premium hardwood scratch brush blocks are kiln-dried to keep wire tufts firmly in place, and hand-selected to ensure straightness and quality. Shoe handle scratch brushes provide good leverage, allowing a more powerful brush stroke than can be achieved with a curved handle brush.



PF85034      **Wire Brush with Scraper**

12

Shoe handle wire brush with scraper. Same as PF85033, but includes 1-7/16" steel scraper attachment.

8530 UNSWORTH AVE. SACRAMENTO, CA 95828-1009 1-916-381-4065	13111 DAHLIA ST. FONTANA, CA 92337-6902 1-909-350-9040	8937 SAN FERNANDO RD. SUN VALLEY, CA 91352-1410 1-818-504-3700	1265 N. CUYAMACA ST. EL CAJON, CA 92020-1549 1-619-449-0333	10010 PORTLAND AVE. TACOMA, WA 98445-3956 1-253-535-5500
---	--	--	---	--

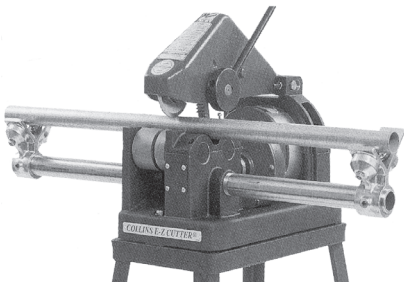

### PIPE CUTTERS & PIPE CUTTER BLADES

Description	Item#	Price
-------------	-------	-------

#### **ELECTRIC PIPE CUTTER**

<b>Collins</b> Electric, E-Z pipe cutter, model A (Includes foot pedal and one cutting blade)	63232	
--	-------	--

#### **BLADES FOR ELECTRIC PIPE CUTTER**

<b>Collins</b> E-Z cutter blade	63235	
---------------------------------	-------	--

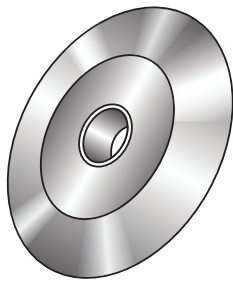

#### **HAND PIPE CUTTER**

<b>Rigid</b> 2" Hand pipe cutter	63233	
<b>Rigid</b> 3" Hand pipe cutter	63233-10	



#### **BLADES FOR HAND PIPE CUTTER**

<b>Cutter</b> blade for 2" Hand pipe cutter	61361	
<b>Cutter</b> blade for 3" & 4" Hand pipe cutter	63231-20	



#### **RECIPROCATING SAW BLADES**



*Thin Flex* blades (TF) cuts stainless steel and other hard, dense materials.  
High speed *Metal Cutting* blades (MC) cuts metals lighter than 18 GA. sheet steel, light tubing, metal molding.

Size	Item#	Blade Length	Teeth Per Inch	Price Each
4TF14	61460	6"	14	
4TF18	61462	6"	18	
4MC24	61464	6"	24	



### LOWBUCK & VOGEL

Description	Item#	Price
<b>LOWBUCK</b>		
Hand notcher, lite Includes # 4 Die set and saddle	63225	
<b>Additional Die sets</b>		
# 4 Die set for 1 3/8", 1 5/8", 1 7/8" dies Includes saddle	63225-10	
# 3 Die set for 2" to 2 1/2" O.D. tubing or fence pipe, <b>not for schedule 40</b> Includes saddle	63226-10	
<b>VOGEL</b>		
# 25 Economy pipe notcher	63227	
# 1400 Press w/o housing	63228	
# 35 Standard housing	63228-10	
<b>PUNCH &amp; DIE ASSEMBLIES FOR # 1400 PRESS</b>		
Vogel # 9202      1 3/8" Die	63228-20	
Vogel # 9203      1 5/8" Die	63228-30	
Vogel # 9204      1 7/8" Die	63228-40	
Vogel # 9205      2 3/8" Die	63228-50	
Vogel # AF-S      ARC-Fit Spring	63229	

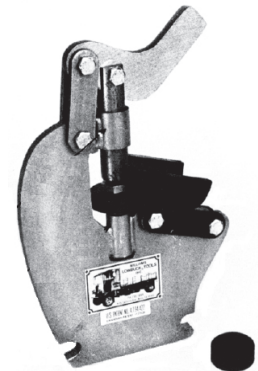

Lowbuck  
# 63225

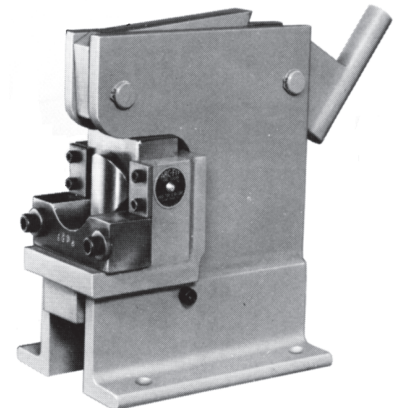

Vogel # 1400 ARC-Fit  
Hand Operated Notcher  
**DOES NOT INCLUDE HOUSING  
AND DIE ASSEMBLY**

SEE ITEMS BELOW

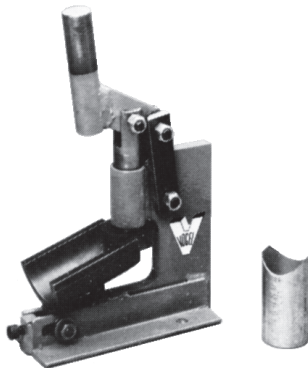

Vogel # 25 Econo Unit

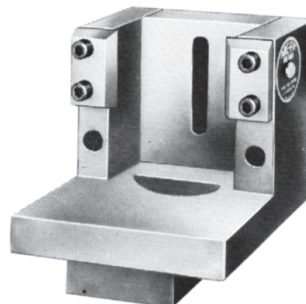

Vogel # 35 ARC-Fit  
Standard Housing

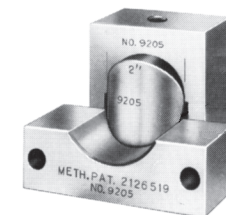

Punch & Die Assembly

ARC-Fit Spring



# 9202  
# 9203  
# 9204  
# 9205

**OTHER SIZES ARE AVAILABLE**



### GROUND HOG EARTH DRILLS GROUND HOG, C-71-5 I/C, less auger

Engine	Item#	Price
5.5 HP Briggs & Stratton I/C	63300	
5.5 HP Honda	63299	

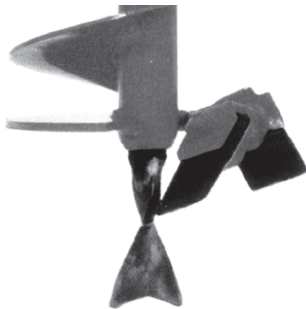

### GROUND HOG, COMBO AUGERS Works best in HARD, COMPACT soils

Description	Item#	Size	Price
Combo (CSD6)	63301	6"	
Combo (CSD8)	63302	8"	
Combo (CSD9)	63303	9"	
Combo (CSD10)	63304	10"	
Combo (CSD12)	63305	12"	

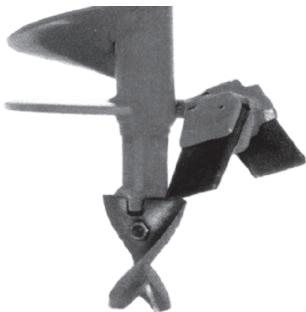

### GROUND HOG, PENGOS AUGERS For use in HARD, DRY, COMPACT soils

Pengo (PSD4)	63306	4"
Pengo (PSD6)	63307	6"
Pengo (PSD7)	63308	7"
Pengo (PSD8)	63309	8"
Pengo (PSD9)	63310	9"
Pengo (PSD10)	63311	10"
Pengo (PSD12)	63312	12"

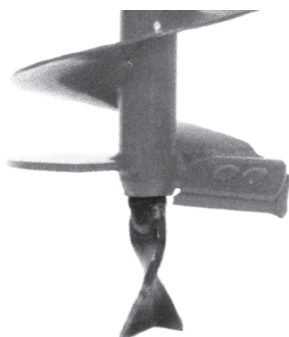

### GROUND HOG, STANDARD AUGERS Works best in LOOSE AND MOIST soils

Standard (SD2)	63313	2" Auger
Standard (SD4)	63314	4" Auger
Standard (SD6)	63315	6" Auger
Standard (SD7)	63316	7" Auger
Standard (SD8)	63317	8" Auger
Standard (SD9)	63318	9" Auger
Standard (SD10)	63319	10" Auger

### GROUND HOG, EXTENSION SHAFTS

Description	Item#	Price
EX1, 1 foot extension shaft	63321	
EX2, 2 foot extension shaft	63322	
EX3, 3 foot extension shaft	63323	
Clevis pin with clip	63325	

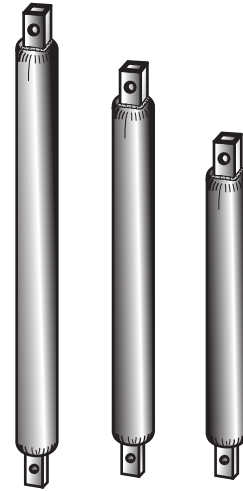

### GROUND HOG, CUTTING BLADES & PILOTS

#### PILOT BLADES

100 pilot, use on SD & CSD augers	63326
SB-25 pilot, use on PSD 2", 6"-12"	63335
SB-45 pilot, use on PSD 4"	63336
101 chipper, use on SD 6"-12"	63332

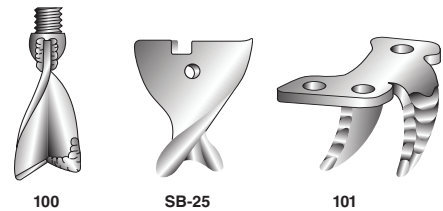

#### PENGO BLADES (INCLUDES RUBBER LOCK)

35 Pengo wisdom tooth	63333
35HF Pengo wisdom tooth (hard faced)	63334
5T30 Pengo super tooth	63331
5T30C Pengo carbide tooth	63331-10

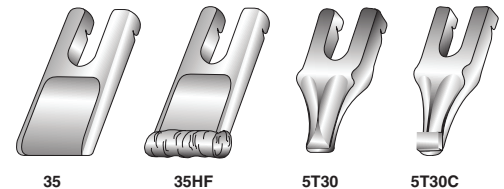

#### STANDARD BLADES

400 blade, use on SD 4"	63327
670 blade, use on SD 6", 7"	63328
800 blade, use on SD 8"	63329
910 blade, use on SD 9", 10"	63330
912 blade, use on SD 12"	63330-10

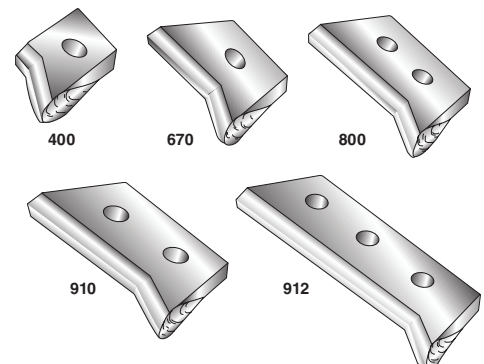

### LITTLE BEAVER POWER UNITS



Model/Engine		Item#	Price
<b>MECHANICAL EARTH DRILLS</b>			
MDL-8B	with 8 HP B&S Intek Pro w/10" wheels (#203432)	63116	
MDL-8H	with 8 HP Honda w/10" wheels (#GX-240)	63112	
	Optional 10" pneumatic wheels to 5B & 5H	63053	
	Optional Roll Cage (requires 10" wheels)	63112-05	
	Optional Roll Cage for 5 HP Honda only	63112-10	
MDL-5B	with 5 HP B&S Intek Pro (#128332)	63111	
MDL-5H	with 5.5 HP Honda (#GX-160)	63110	

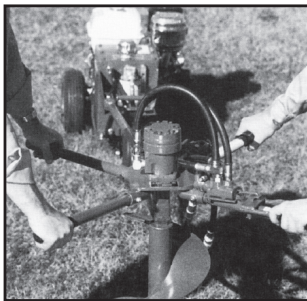

### HYDRAULIC EARTH DRILLS

HYD-TB11H	Hydraulic Towerable Drill, 11 HP Honda (#GX-340)	63117	
	11 HP B&S Power Source w/ 1 Man Handle Attachment	63118	
	11 HP B&S Power Source w/ 2 Man Handle Attachment	63119	
	11 HP Honda Power Source w/ 1 Man Handle Attachment	63120	
	11 HP Honda Power Source w/ 2 Man Handle Attachment	63120-10	
HYD-AH60	Anchor handle attachment	63121	
HYD-2MHNPT	Optional 2 Man Handle for Remote Drilling	63122	

### SNAP ON AUGERS

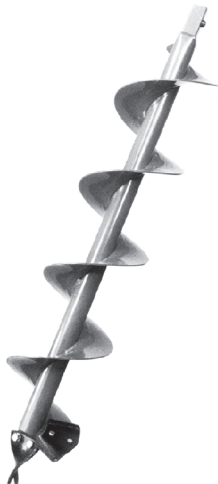

Size	Item#	Price	Size	Item#	Price
3" x 36"	63124		1 1/2" x 42"	63135	
4" x 36"	63126		2" x 42"	63136	
5" x 36"	63127		3" x 42"	63137	
6" x 36"	63128		4" x 42"	63138	
7" x 36"	63129		5" x 42"	63139	
8" x 36"	63130		6" x 42"	63140	
9" x 36"	63131		7" x 42"	63141	
10" x 36"	63132		8" x 42"	63142	
12" x 36"	63133		9" x 42"	63143	
14" x 36"	63134		10" x 42"	63144	
			12" x 42"	63145	

• Call for Quotation

### SNAP ON EXTENSIONS

Description	Item#	Price
3" x 36"	63146	
4" x 36"	63147	
5" x 36"	63148	
6" x 36"	63149	
7" x 36"	63150	
8" x 36"	63151	
9" x 36"	63152	
10" x 36"	63153	
12" x 36"	63154	
18" Tube Extension	63155	
36" Tube Extension	63156	



### REPLACEMENT POINTS & BLADES

Screw on point for 1 1/2" augers	63157
Screw on point for 2" augers	63158
Screw on point for 3" augers	63159
Point fits	
4", 5", 6", 7", 8", 9", 10", 12" augers	63160
Screw on point for 16" auger only	63161
4" and 5" blade	63162
6" and 7" blade	63163
8" blade	63164
9" and 10" blade	63165
12" blade	63166

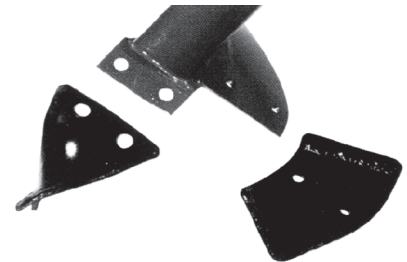

### CARBIDE BLADES — For Snap-on Augers

1 1/2", 2", & 3" blades are screw-on & fit snap-on augers only.

1 1/2" carbide blade	63168
2" carbide blade	63169
3" carbide blade	63170
4" carbide blade	63171
5" carbide blade	63172
6" carbide blade	63173
7" carbide blade	63174
8" carbide blade	63175
9" carbide blade	63176

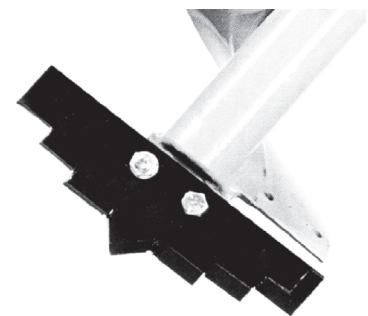

4" thru 14" include mounting bolts & lock nuts. • Call for Quotation

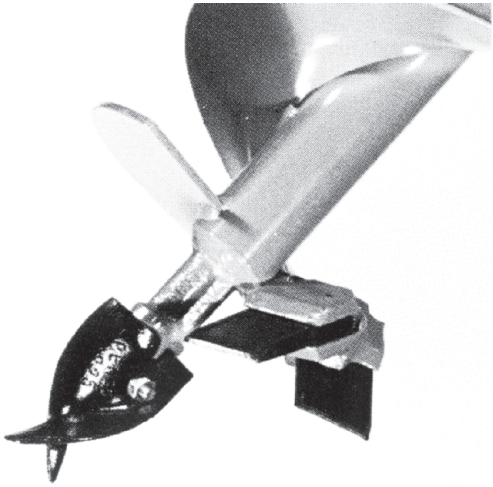

### PENGO AUGERS

Size	Item#	Price
6" x 36"	63177	
6" x 42"	63178	
7" x 36"	63179	
7" x 42"	63180	
8" x 36"	63181	
8" x 42"	63182	
9" x 36"	63183	
9" x 42"	63184	
10" x 36"	63185	
10" x 42"	63186	
12" x 36"	63187	
12" x 42"	63189	

NOT ALL SIZES IN STOCK

— Pengo Points & Blades are standard on all Pengo Augers —  
— Blades include Rubber Locks —



### SCREW-ON

### AUGERS & EXTENSIONS

Available:

— 1 1/2" to 3" Hex Auger Extensions —  
— Hex Points, and —  
— Hex Auger Adaptors —

• Call for Quotation